



KITTELSON & ASSOCIATES, INC.

TRANSPORTATION ENGINEERING / PLANNING

354 SW Upper Terrace Drive, Suite 101, Bend, Oregon 97702 P 541.312.8300 F 541.312.4585

TECHNICAL MEMORANDUM #3

Gilliam County Transportation System Plan Update

Existing Conditions Inventory & Analysis

Date: November 27, 2014 Project #: 17679
 To: Michael Duncan, ODOT
 Susie Anderson, Gilliam County
 From: Casey Bergh, PE, Ashleigh Griffin, and Marc Butorac, PE, PTOE
 cc: Project Advisory Committee
 Technical Advisory Committee

This memorandum inventories and evaluates the existing conditions of the Gilliam County transportation system to establish a baseline for the planning efforts to be conducted as part of the Transportation System Plan (TSP) update. The information was obtained and assembled using Geographic Information System (GIS) files, data provided by Gilliam County, inventory conducted using Google Earth aerial images, site visits, and studies provided or produced by Gilliam County and the Oregon Department of Transportation (ODOT).

The information contained in this memorandum is organized into a series of sections, listed below.

Study Area	2
Land Use and Population.....	4
Street System and Traffic Analysis	8
Collision History and Crash Analysis	28
Pedestrian and Bicyclist System	35
Public Transportation System.....	39
Truck Freight Routes	39
Rail System	42
Air Transportation System.....	43
InterModal Connections.....	45
Bridge Conditions	46
Marine Transportation System.....	49
Pipeline transportation system	49
Funding Inventory & Analysis	49

The majority of the inventory and analysis results are presented in figures and tabular form with supplemental text provided, as needed, to explain the illustrated information. This memorandum will identify existing transportation needs based on currently adopted performance measures that will be addressed in the Transportation System Plan (TSP) Update through policies, projects, programs, pilot projects and refinement studies to improve the system.

STUDY AREA

The Transportation System Plan (TSP) focuses on the areas within Gilliam County, as shown in Figure 3-1. Six intersections and seven roadway segments will be evaluated operationally during the study. These study intersections and segments are shown in Figure 3-1 and summarized in Table 1.

Table 1. Study Intersections and Segments

Intersection/Segment Number	Intersection/Segment Name	Location
1	Walnut Street/Main Street	Condon
2	E Bayard Street/Main Street	Condon
3	I-84/Beech Street	Arlington
4	I-84/Locust Street	Arlington
5	I-84/OR 74 (Eastbound Ramps)	County
6	Cedar Springs Lane/OR 19	County
A	Lonerock Road	0.5 mi from OR 206 intersection
B	Baseline Road	0.25 mi from OR 19 intersection
C	Fourmile Road	0.25 mi. from OR 206 intersection
D	Blalock Canyon Road	0.25 mi. from I-84 intersection
E	Quinton Canyon Road	0.25 mi. from I-84 intersection
F	Mikkalo Lane	0.25 mi. from OR 19 intersection
G	E Bayard Street	At Condon High School

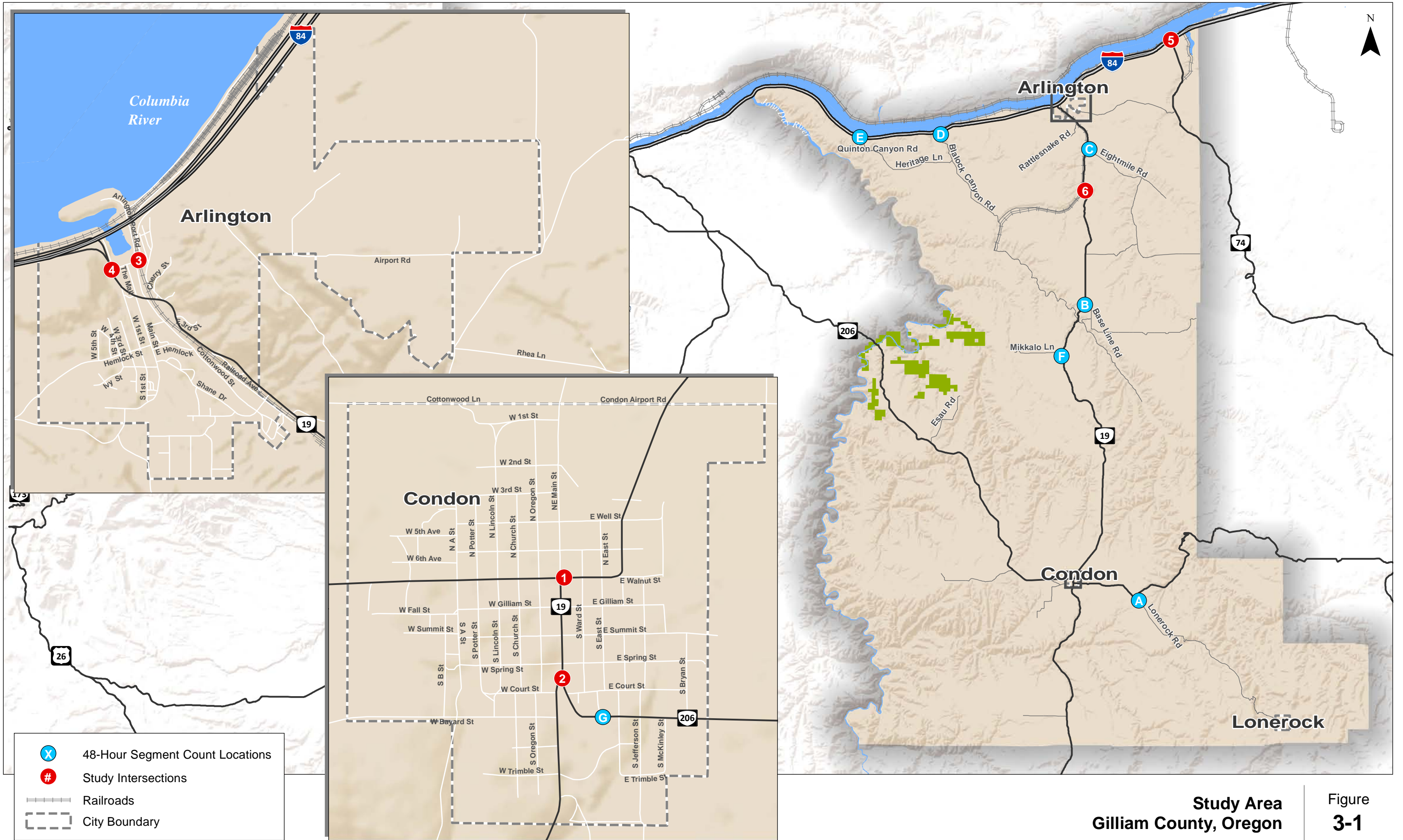

Study Area
Gilliam County, Oregon

Figure
3-1

K:\H_Perland\proj\17679 - Gilliam County TSP\gis\3-1 Study Area.mxd - agriffin - 11:12 AM 11/26/2014

LAND USE AND POPULATION

The land use and population inventory identifies existing, planned, and potential land uses. The land use and population inventory will inform existing and future conditions analyses, particularly as the project team works with the community to develop future alternative scenarios that capture the County's vision.

As shown in Figure 3-2, key activity centers and destinations within the County include:

- Arlington and Condon Schools
- Condon City Park
- Earl Snell Memorial Park in Arlington
- Arlington and Condon Golf Courses
- Port of Arlington
- Gilliam County Courthouse
- Arlington and Condon Airports
- Columbia Ridge Landfill
- Wind Turbine farms
- Agricultural farms
- City of Lonerock

In addition to these key activity centers in the County, OR 74 is designated as a scenic byway and may attract visitors from other regions of the state. The cities of Arlington and Condon also have downtown commercial centers that generate regional trips for shopping, dining, and other purposes.

Appendix 1 contains exhibits illustrating the buildable lands inventory map for the communities of Arlington, Condon, and Lonerock. These exhibits show existing land uses and areas where future growth is possible within the respective Urban Growth Boundary (UGB) areas. The following three sections describe the buildable lands within each of the three cities.

City of Arlington

As shown in the exhibit, the central business district of Arlington is located primarily within the triangle area formed by Cottonwood Street and OR 19 south of the I-84 interchange ramps. The central business district extends south down OR 19 as well. The majority of the residential lands are located in the central and south areas of the City, around the public school lands. The Arlington Buildable Lands Map shown in *Appendix 1* was completed around 2003 for the City of Arlington. Since this inventory was completed, six new homes have been completed within the City, and two existing houses and one church have burned down. The buildable lands inventory indicates opportunity for infill residential development throughout the City, and potential for larger development in the eastern area of the City (near the airport).

The Port of Arlington is encouraging industrial development at one of three industrial parks that are zoned for industrial land use: the Arlington Mesa Industrial Park, the Columbia Plateau Industrial Park, and the Shutler Station Industrial Park.

The Airport is adjacent to the Arlington Mesa Industrial Park which has 30 available acres zoned M1 and M2 (industrial) for airport development, as shown in Exhibit 1. The Airport is located in the Enterprise Zone within the City Limits of Arlington and maintains an Airport Development (AD) overlay zone.

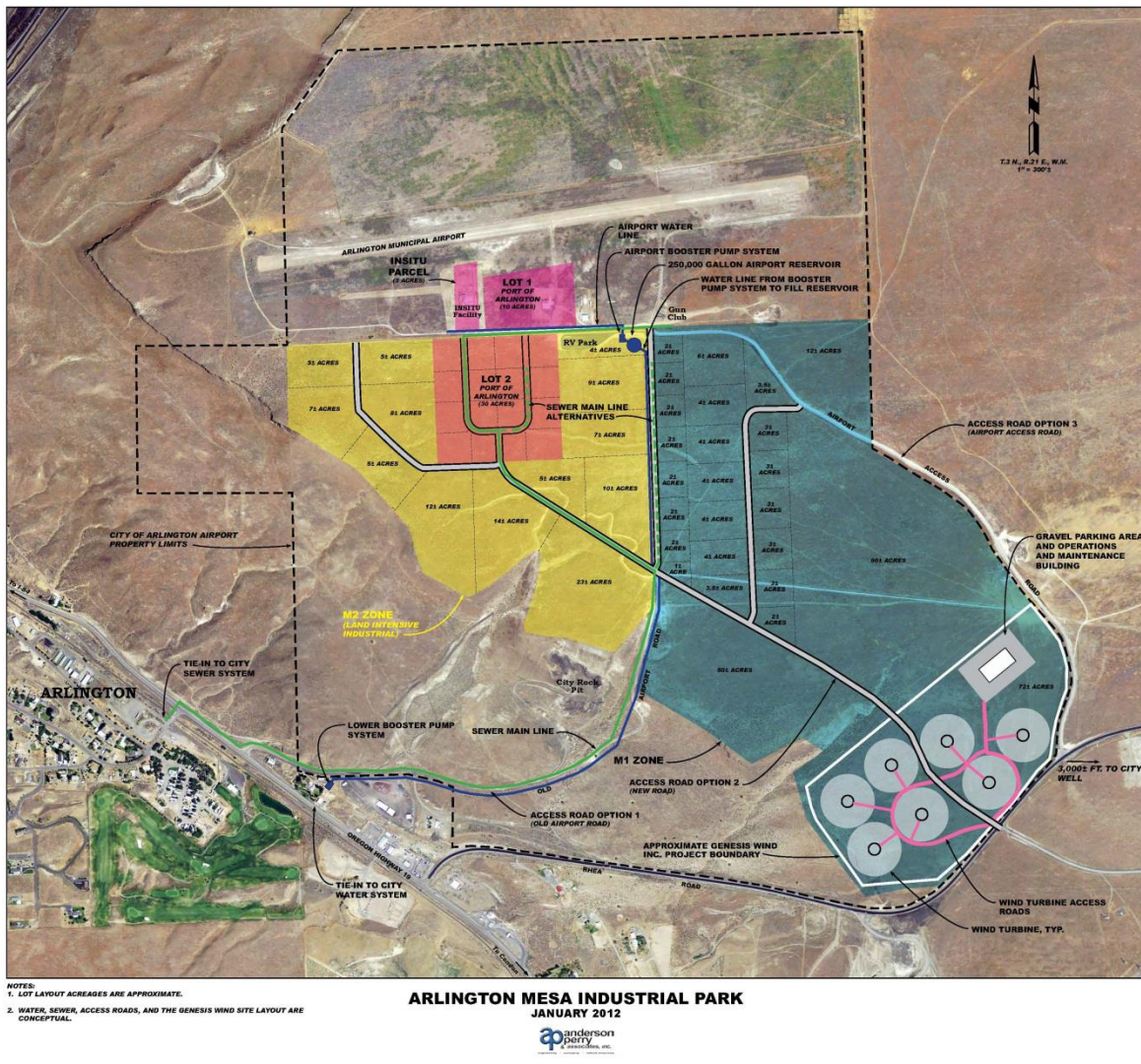

Exhibit 1. Arlington Mesa Industrial Park Plan

City of Condon

The City of Condon buildable lands map is also shown in *Appendix 1*. Since this map was updated in 2011, five new homes have been built and one commercial structure has been remodeled. As shown

in the exhibit, the majority of the commercial land is located along Main Street, with the majority of the industrial land located along the former railroad track alignment on the northeast quadrant of town. Residential land surrounds the commercial core area, and public land for schools and parks is located in the southeast, northeast, and northwest quadrants of the City. The majority of the buildable lands are located on the east and west sides of the City, with many residential parcels available throughout town.

City of Lonerock

Appendix 1 also includes the buildable lands inventory map for Lonerock. Lonerock does not have any commercial land use within the City. The town is primarily residential with several supporting public land uses including a community hall. The buildable lands inventory for Lonerock indicates that residential parcels are available throughout the City, with the most availability located in the far quadrants of the City.

Priority Development Areas

Based on these inventories, areas prioritized for growth within the cities and County include:

- Industrial development within the industrial lands in Arlington and the County, including:
 - Old Airforce Base
 - Shutler Station
 - Arlington Mesa Industrial Park
 - Columbia Ridge Landfill
 - Waste Management
- Commercial development within the cities, and
- Dense residential development within the cities.

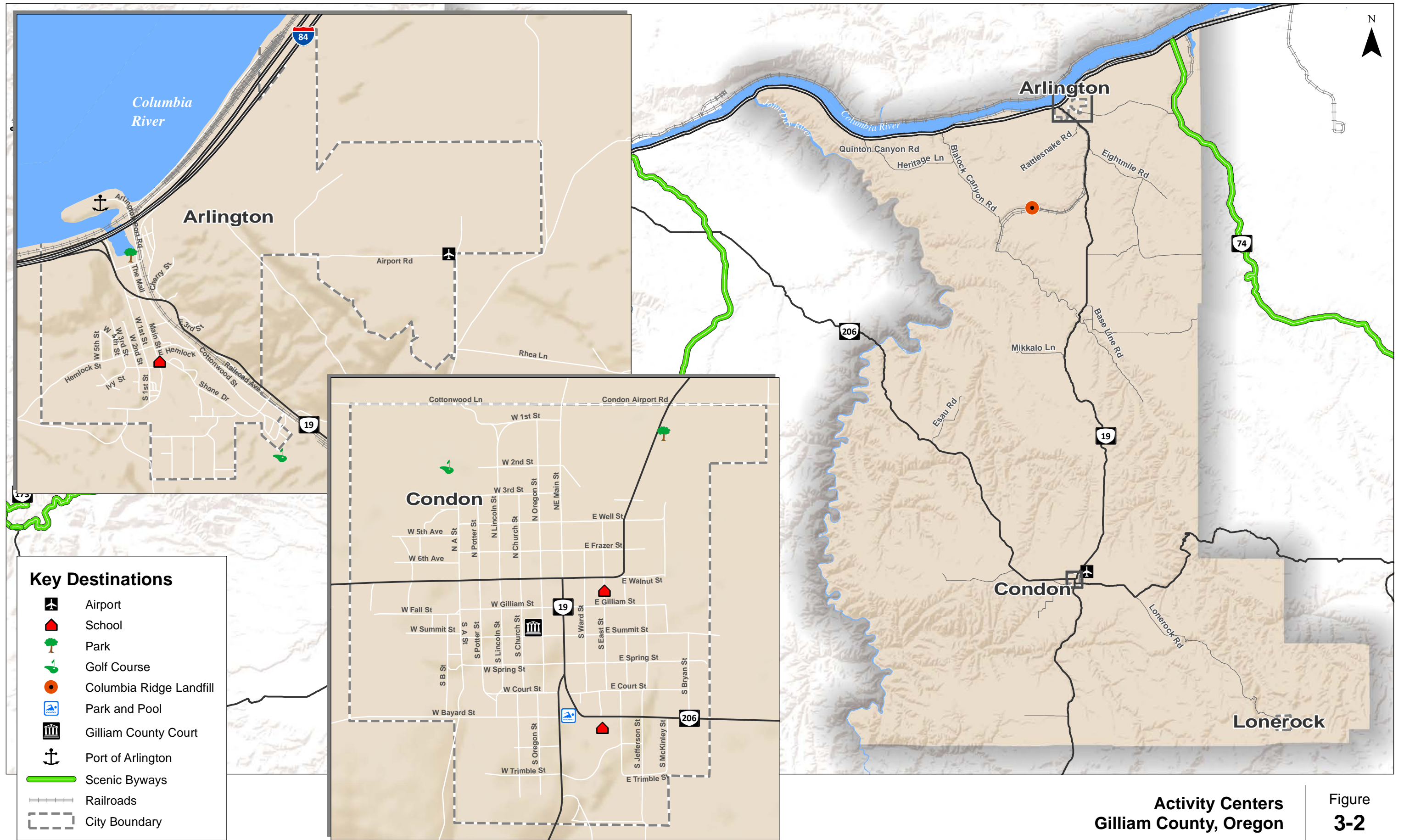

Activity Centers
Gilliam County, Oregon

Figure
3-2

H:\proj\117679 - Gilliam County TSP\fig3-2_Activity Centers.mxd - 11:59 AM 11/2/2014

Population Inventory

By Oregon Revised Statute 195.034, the Counties are directed to formulate and adopt coordinated population projections among the County and its incorporated Cities. Further, the Statute requires population projections for Counties be prepared by the Portland State University Center for Population Research. The latest 2015-2040 projections were prepared in 2013 for Gilliam County's and are shown in Table 2. The total population for the County is shown in the left column of Table 1. The other four columns represent the unincorporated area of the County and the Cities of Condon, Arlington, and Lonerock. The basis for the City population projections is historical proportion of the County's total population over time. Condon has generally maintained 39% of the County's population, Arlington has accounted for 26%, and the City of Lonerock has accounted for 1%. Those proportions were projected through the years from 2015 to 2040. This population projection will be adopted as part of the Transportation System Plan and will be the County's official population projections until the next update is complete.

Table 2. Gilliam County Population Projections

Year	Population Projections				
	Gilliam County (Total)	Unincorporated Area (34%)	Condon (39%)	Arlington (26%)	Lonerock (1%)
2010*	1871	582	682	586	21
2015	1958	655	764	509	20
2020	2062	701	804	536	21
2025	2172	739	847	564	22
2030	2280	776	889	592	23
2035	2378	809	927	618	24
2040	2472	840	964	643	25

*2010 population totals are provided, based on the 2010 census data.

As shown in Table 2, the County's population is estimated to grow by just over 400 persons in the TSP Update horizon year of 2035.

STREET SYSTEM AND TRAFFIC ANALYSIS

Three state highways and a network of highways, arterials, collectors, and local streets maintained by the County serve Gilliam County. Primary roadway facilities, their characteristics, and existing operational performance are summarized below.

Street System Overview

Roadways within Gilliam County fall under the jurisdiction of the state (ODOT), the County, or local cities. The following sections describe the jurisdiction and characteristics of the roadways.

State Roadways

The state facilities within Gilliam County provide interstate, statewide, and regional connectivity. These facilities include Interstate 84 (I-84), Oregon Highway 19 (OR 19), Oregon Highway 206 (OR 206), and Oregon Highway 74 (OR 74). The state facilities serve two of the three cities in Gilliam County. I-84 and OR 19 provide connections to the City of Arlington, and OR 19 and OR 206 provide connections to the City of Condon.

County Roadways

Eighty-five roadways, totaling an estimated 395 miles, are under the County's jurisdiction. Ten percent of the roadway miles are paved, 15 percent are chip sealed, and 75 percent are gravel roads. The County roads provide connections to the state highway system and serve rural areas and the city of Lonerock.

City Roadways

The City of Condon is comprised of streets in a grid pattern, with Main Street running north-south down the middle of the City. OR 19 and OR 206 meet and share the alignment with Main Street through the downtown area. Blocks in the downtown area are generally 300 feet wide (east-west) and 500 feet long (north-south).

The City of Arlington is comprised of roadways that are either state, county, or city operated facilities. Most of the roadways are located west of OR 19 and the railroad tracks.

The City of Lonerock's roadways are maintained by Gilliam County. The city's seven roads form a small grid pattern.

Street System Characteristics

The following set of figures and tables illustrate and summarize the current street characteristics within the County including roadway classifications, roadway standards, and intersection characteristics.

Functional classification levels for roadways are used to establish a hierarchy of roadways based on their primary function (moving people across regions or providing access to local destinations). These classification levels are identified by ODOT for state facilities, the County for County facilities, and local agencies for their own classification levels within their community. The classification levels also

determine the recommended roadway cross-section for different facilities. The functional classification of roadways that local agencies typically establish is based on the following hierarchy:

- **Arterials** represent the highest class of roadway (other than Interstates). These roadways are intended to provide mobility by serving high volumes of traffic, particularly through traffic, at higher speeds. They also serve truck movements and should emphasize traffic movement over local land access. In some cases, arterial streets are further designated as “major/principal” or “minor.” Major/principal arterials have higher design speed, fewer accesses per mile, and usually do not permit direct private driveway access. Minor arterial provide slightly lower travel speeds and have a few more accesses than major/principal arterials.
- **Collectors** represent the intermediate roadway class. As their name suggests, these roadways collect traffic from the local street system and distribute it to the arterial street system. These roadways provide a balance between traffic movement and land access and should provide extended continuous stretches of roadway to facilitate traffic circulation through the county. Collector streets are sometimes divided into two categories – urban collector/rural major collector and minor collector. Urban collector/rural major collector have the same basic roadway design but are differentiated by urban features like bike lanes and sidewalk as well as adjacent land use (i.e., the land is inside or outside the Urban Growth Boundary). Minor collectors serve lower volume of traffic and have lower design speeds than the urban collector/rural major collector.
- **Local** roads and streets are the lowest roadway class. Their primary purpose is to provide local land access and to carry locally generated traffic at relatively low speeds to the collector street system. Local streets should provide connectivity through neighborhoods but should be designed to discourage cut-through vehicular traffic.

State Facilities

Figure 3-3 shows the ODOT functional classification for state facilities in the County. Table 3 summarizes the roadway characteristics of each of these facilities, including posted speed limit and number of lanes. Because Arlington and Condon are bisected by state highways that are classified as minor arterials, the highways must balance carrying through traffic and accommodating access to local destinations.

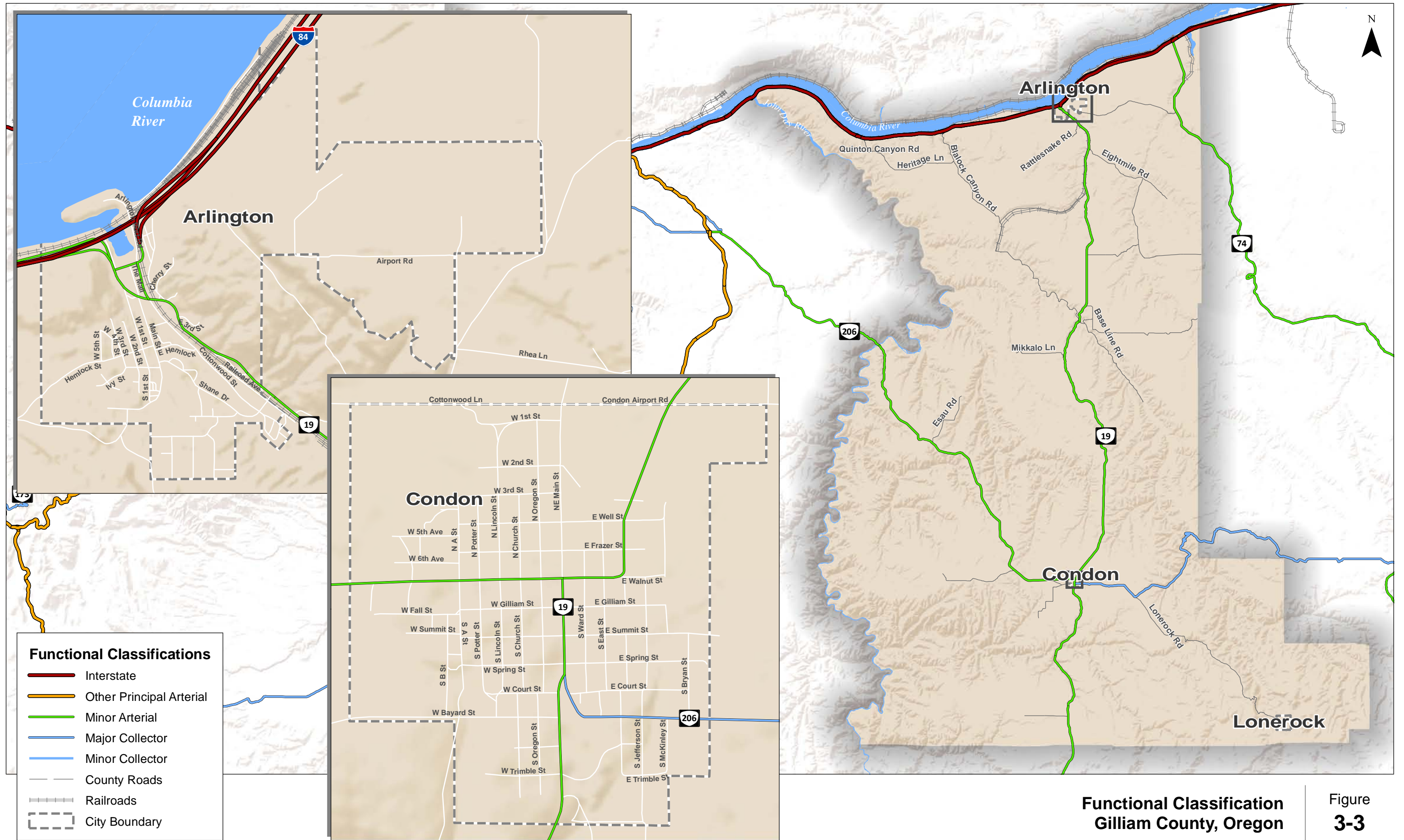

H:\proj\117679 - Gilliam County TSP\fig3-3 Functional Classification.mxd - jsommer/ls - 11:59 AM 11/21/2014

**Functional Classification
Gilliam County, Oregon** | **Figure
3-3**

Table 3 summarizes the characteristics of the state highways in the County, and Figure 3-4 summarizes the characteristics of the study intersections. Each of the study intersections is under ODOT’s jurisdiction. All of the study intersections are unsignalized; no signalized intersections are present within Gilliam County.

Table 3. State Highways Functional Classification

Route Name	Facility Extents	ODOT Facility Designation	ODOT Functional Classification	Posted Speed Limit	Number of Lanes	Pavement Condition (2012)
Interstate 84	Entire Section within County Limits	Interstate	Interstate	65	4	Good - Very Good
OR 206	West of Condon	Regional Highway	Minor Arterial	55	2	Good
	East of Condon	District Highway	Major Collector	55*	2	Good
OR 19	Entire Section within County Limits	Regional Highway	Minor Arterial	55*	2	Good – Very Good
OR 74	Entire Section within County Limits	District Highway	Minor Arterial	55	2	Good

*Within the cities of Condon and Arlington, the posted speed limit varies between 20 and 45 miles per hour (mph) along OR 206 and OR 19.



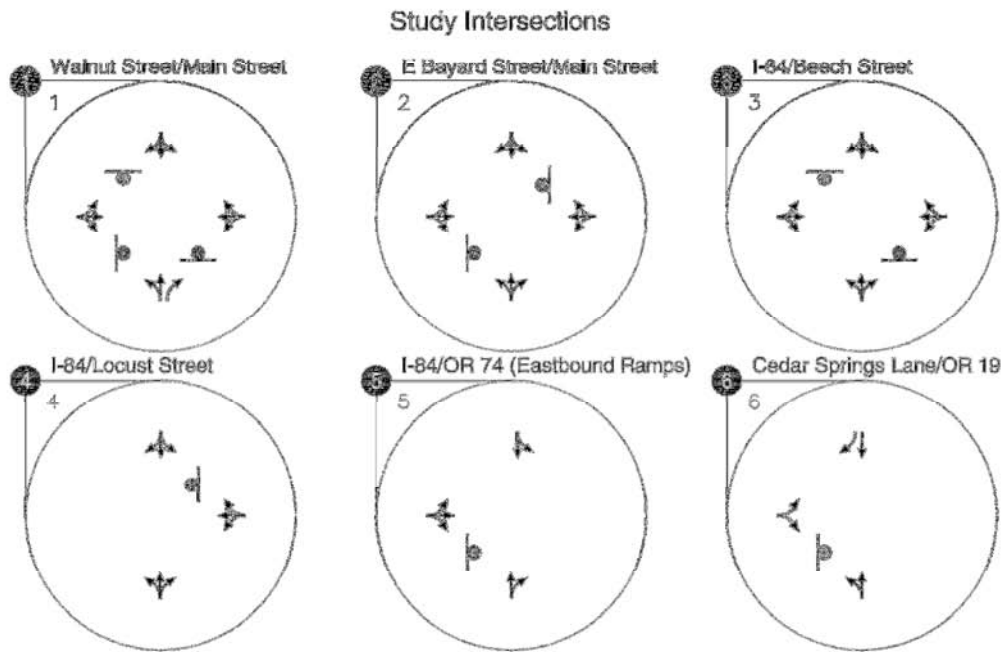

Figure 3-4. Study Intersection Existing Lane Configurations and Control

DRAFT

County Facilities

Gilliam County follows ODOT's roadway functional classification system by dividing county roads into three levels: urban collector/rural major collector, minor collector, and local roads. State highways are the only facilities in the County that are classified as arterials. Twelve county roads are classified as rural major collectors, ten as minor collectors, and 62 as local roads. Cottonwood Road is classified as a minor arterial as it shares its alignment with the Wasco-Heppner Highway.

City Facilities

The local cities do not have a separate functional classification system. The majority of the roads within the Cities, other than the state highways, generally have the characteristics of local streets.

DRAFT

Roadway Cross-Section Standards

Roadway functional classifications typically inform the recommended roadway cross-section design. Cross-section design depends on a roadway’s primary function.

County Facilities

The County’s current TSP identifies rural roadway design standards, which are summarized in Table 4. The County also has recommended roadway widths which recommended to serve the forecast future traffic demands in the County. These are summarized in Table 5.

Rural roadways in the County are not currently required to have bike lanes or marked bicyclist facilities. The roadway design standards indicate that bicyclists shall be accommodated on the shoulder when appropriate based on the facility. Rural roadways are also not required to have separate pedestrian facilities.

Table 4. Gilliam County Rural Roadway Design Standards

Classification	Right-of-Way Width (ft)	Roadway		Shoulder	
		Width (ft)	Surface	Width (ft)	Surface
Arterial Street	60-120	32-40	Paved	4-8	Paved
Collector Street	60-80	24-32	Paved/gravel	2-4	Paved/gravel
Local Street	60	24-28	Paved/gravel	2-4	Paved/gravel
Radius for cul-de-sac turn-around	50	40	-	-	-

Table 5. Recommended Shoulder Widths on Rural Roads

Road Use	Local Streets	Major and Minor Collectors	Arterial Streets
ADT under 400	2 ft	2 ft	4 ft
ADT over 400 and DHV& under 100	2 ft	4 ft	6 ft
DHV 100 – 200	4 ft	6 ft	6 ft
DHV 200—400	6 ft	8 ft	8 ft
DHV over 400	8 ft	8 ft	8 ft

*DHV (Design Hour Volume) is the expected two-way traffic in the peak design hour (usually commuter times), usually 13 to 25% ADT.

Note: ADT = Average Daily Traffic volume

Local Facilities

The City of Condon does not have identified street design standards. The majority of the non-state highway streets have a 60-foot right-of-way, with pavement width between 15 and 25 feet comprised of two travel lanes and narrows shoulders. Most streets are chip-sealed. Main Street has sidewalks of

at least 10-feet in width, while other streets within the City have occasional, disconnected sidewalks varying between three and five feet in width.

The City of Arlington has recommended street design standards, as summarized in Table 6.

Table 6. Recommended Street Design Standards for the City of Arlington

Classification	Pavement Width	Right-of-Way Width	Number/Width			Planting, Utility, Sidewalks
			Travel Lanes	Parking Lanes	Bike Lanes	
Arterial – Option 1	36 ft	70 ft	2/12 ft	None	2/6 ft	12 ft
Arterial – Option 2	52 ft	80 ft	2/12 ft	2/8 ft	2/6 ft	14 ft
Arterial – Option 2	48 ft	70-80 ft	3/12 ft	None	2/6 ft	11-16 ft
Collector	36 ft	60 ft	2/10 ft	2/8 ft	none	13 ft
Minor – Option 1	24 ft	50 ft	2/10 ft	None	none	15 ft
Minor – Option 2	34 ft	50 ft	2/12 ft	2/7 ft	none	13 ft
Alley	20 ft	20 ft	2/10 ft	none	none	none

The City of Lonerock has a rural character and therefore follows the County’s rural roadway standards. Lonerock has collector and local streets.

Access Spacing and Access Management

Providing adequate access to other public roadways, land uses, and destinations is a critical part of an effective transportation system. However, it is necessary to balance access with the need for mobility and safety on the system. Providing access via other public streets and driveways to land uses creates friction from a traffic operations perspective thereby reducing mobility and introducing conflict points that increase the potential for crashes.

Access management strategies and implementation require careful consideration to balance access and mobility in a safe and efficient manner. In general, access management is generally more stringent on higher classified roads where mobility is the highest priority. Exhibit 2 illustrates the relationship between access and mobility relative to the street classifications in the Gilliam County area. OR 19 and OR 206 bisect the cities of Arlington and Condon and run through the downtown commercial areas of both cities. Therefore, these facilities must balance carrying through traffic and providing access within the downtown cores.

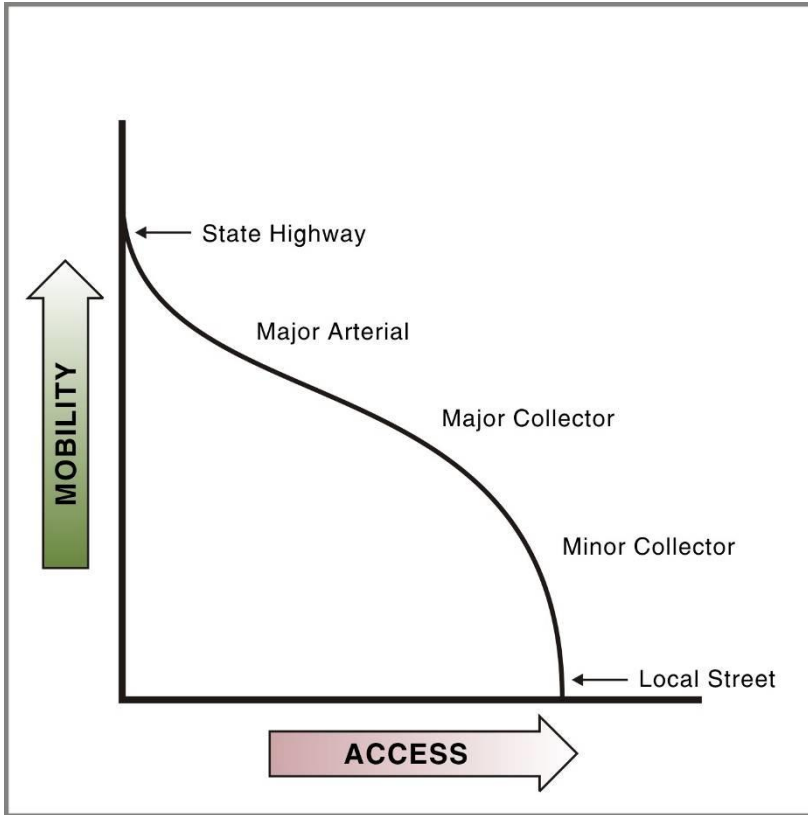

Exhibit 2. Relationship between Access, Mobility, and Functional Classification

State Facilities

ODOT specifies access management spacing standards for the state facilities in the Oregon Highway Plan (OHP, Reference 1). The corresponding access management spacing standards for state facilities within Gilliam County are summarized in Table 7. These standards are based on the 2012 AADT (Annual Average Daily Traffic volume), posted speed limit, proximity to urban areas, and functional classification.

Table 7. Access Management Spacing Standards for Highway Segments

Route Name	Description	Functional Classification	2012 AADT	Posted Speed (mph)	Access Spacing Standard (feet)
Interstate 84	Entire Section within County Limits	Interstate	>5,000	65	10,560
OR 206	West of Condon	Regional Highway	<5,000	55	650
	East of Condon	District Highway	<5,000	55	650
	Within Condon City Limits	Regional/ District Highway	<5,000	40/30/20	360/250/150
OR 19	Entire Section within County Limits, Outside of Cities	Regional Highway	<5,000	55	650
	Within Arlington City Limits		<5,000	55/45/25	650/360/150
	Within Condon City Limits		<5,000	40/30/20	360/250/150
OR 74	Entire Section within County Limits	District Highway	<5,000	55	650

Figure 3-5 shows the location of access points along state facilities in the two cities. As shown in Figure 3-5, the location of access points within the city limits does not meet the access spacing standards where the state highways also function as main streets in the communities.

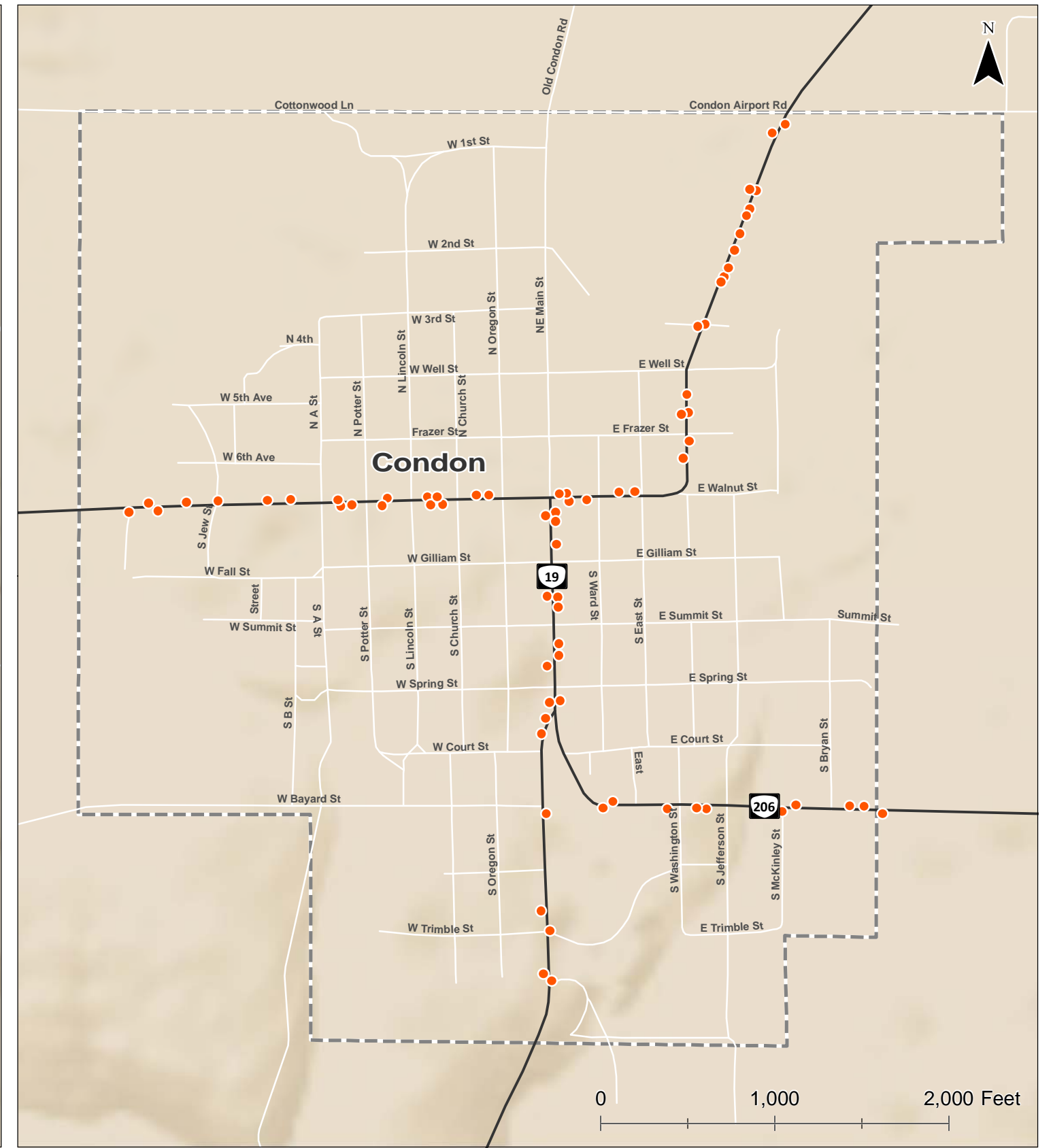

- Access Points on State Facilities
- Railroads
- City Boundary

**Access Points
Gilliam County, Oregon**

**Figure
3-5**

H:\proj\117679 - Gilliam County TSP\fig3-5 Access Points.mxd - 11:59 AM 11/2/2014

County Facilities

The County has its own access spacing standards for County facilities. These standards are intended to be applied as new development occurs rather than to be used to eliminate existing driveways. The access spacing standards for County facilities are summarized in Table 8.

Table 8. Access Management Spacing Standards for Rural County Segments

Functional Classification	Intersection			
	Public Road		Private Drive	
	Type	Spacing	Type	Spacing
Collector	At grade	¼ mile	Lt/Rt Turns	1,200 ft
Local Street	At grade	200-400 ft	Lt/Rt Turns	Vary

City Facilities

The majority of streets, other than state highways, within the City of Condon function as local streets, which are intended to provide access to local destinations and serve relatively low traffic volumes. The City of Condon does not have access management standards for these streets, but the streets are generally intended to serve multiple access locations in close proximity.

The City of Arlington has minimum connection spacing for its roadway, depending on functional classification, as summarized in Table 9.

Table 9. Minimum Spacing Requirements for the City of Arlington

Functional Classification	Public Road Spacing	Private Drive Spacing
Arterial: I-84	2-3 mi.	NA
OR 19: I-84 – Dahlia St	300 ft	150 ft
Other Urban Areas	¼ mi.	500 ft
Other arterials in UGB	600 ft	300 ft
Collector	300 ft	150 ft
Minor Street	300 ft	Each Lot

The City of Lonerock follows the County’s TSP and therefore does not have its own spacing standards.

On-Street Parking Inventory



Figure 3-6 shows the inventory of on-street parking in the downtown areas of Arlington and Condon. Arlington accommodates all of its downtown parking with off-street lots within the commercial area and across the street, adjacent to Earl Snell Memorial Park. Although Condon does not have marked on-street parking spaces, the roadway cross-section accommodates on-street parking along Main Street in downtown, alongside streets that abut Main Street, and around the Courthouse. There is

also parking available next to the Courthouse in parallel on-street spaces and an off-street lot on Church Street.

Based on observations, parking demand does not generally exceed available capacity in Condon or Arlington during typical use. However, Arlington hosts several large events during the summer months. During these events, there is inadequate parking which leads to people parking illegally throughout the City.

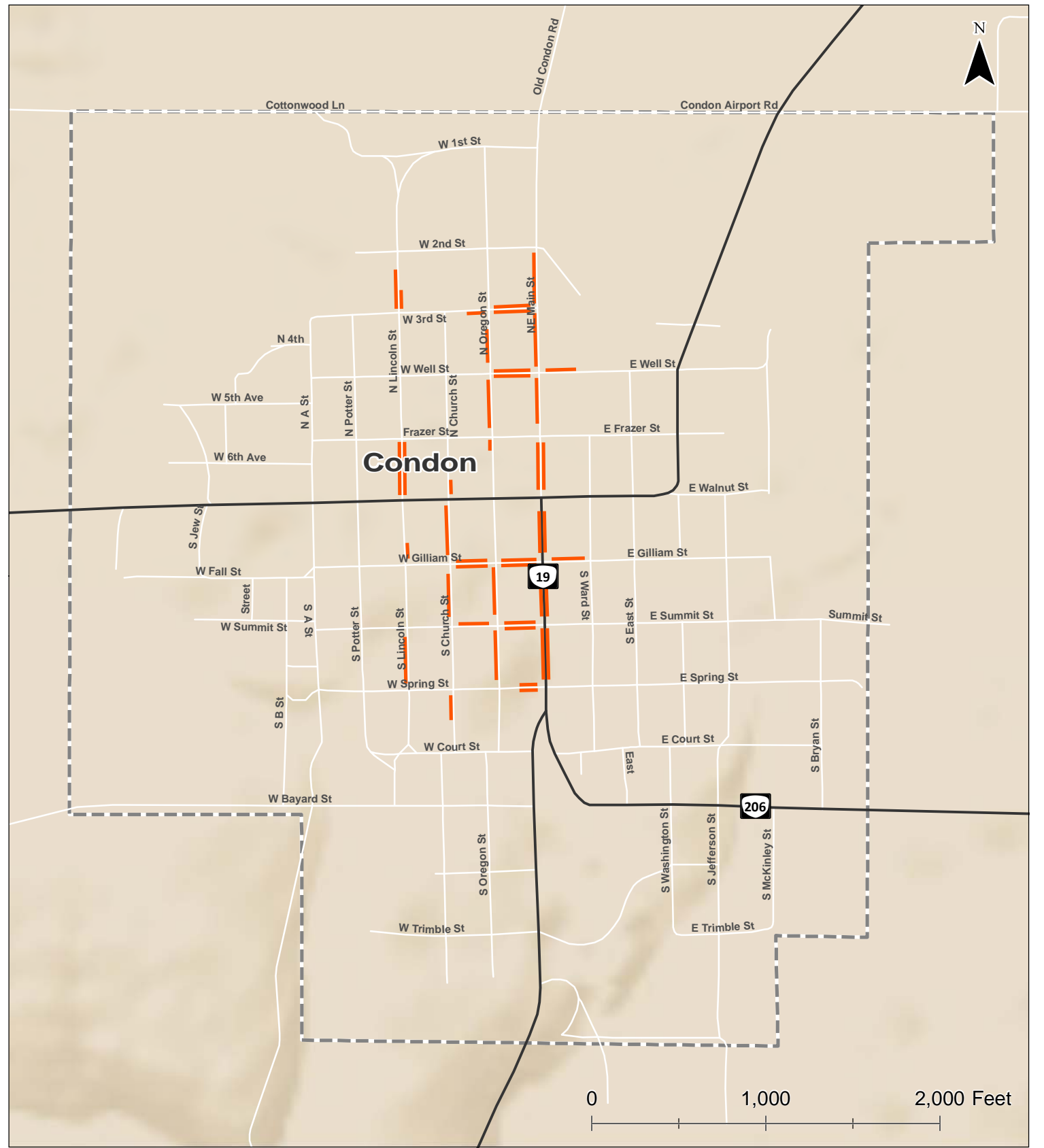
DRAFT



-  Parking
-  Railroads
-  City Boundary

**Parking Inventory
Gilliam County, Oregon** | **Figure
3-6**

H:\proj\117679 - Gilliam County TSP\figs\3-6 Parking Inventory.mxd - jsummerlin - 11:59 AM 11/21/2014

Street System Traffic Analysis

The focus of this section is to report the existing traffic operations for study intersections and roadway segments identified for the TSP update. The sub-sections below present information on the traffic count data used in the evaluation, the analysis methodology applied, the operational standards used to assess the results, and the traffic operations results for the study intersections. *Appendix 1* contains the traffic count data obtained from ODOT and used in the analysis. *Appendix 3* contains the Methodology Memorandum documenting the analysis method applied. *Appendix 5* contains the existing conditions traffic operations and queuing analysis worksheets.

Analysis Methodology and Performance Standards

All operations analysis described in this report were performed in accordance with the procedures in the *2010 Highway Capacity Manual* (Reference 2).

Per the Methodology Memorandum (see *Appendix 3*) and the ODOT *Analysis Procedures Manual* (APM) (Reference 3), intersection operational evaluations were conducted based on the peak 15-minute flow rate observed during the weekday peak hour. Using the peak 15-minute flow rate ensures this analysis is based on a reasonable worst-case scenario. For this reason, the analysis reflects conditions that are likely to occur for 15 minutes out of each average weekday peak hour. The transportation system will likely operate under conditions better than those described in this report during other typical time periods.

The operational results for study intersections and segments were compared with their corresponding mobility targets, summarized in Table 10 and Table 11, to assess performance and identify potential areas for improvement. Gilliam County does not have operational standards for roadway facilities. ODOT operational targets are identified in the Oregon Highway Plan (OHP, Reference 1) and are summarized below for the state highways within the County.

Table 10. Volume to Capacity Ratio Targets for Peak Hour Operation Conditions

Route Name	Facility Extents	Facility Designation	Inside UGB			Outside UGB	
			Posted speed <= 35 mph	Speed > 35 mph but <45 mph	Speed limit >= 45 mph	Unincorporated Communities	Rural Lands
Interstate 84	Entire Section within County Limits	Interstate	N/A	N/A	0.70	0.70	0.70
OR 206	West of Condon	Regional Highway	N/A	N/A	N/A	0.75	0.70
	East of Condon	District Highway	N/A	N/A	N/A	0.80	0.75
	Within Condon City Limits	Regional Highway	0.85	0.80	0.75	N/A	N/A
	Within Condon City Limits	District Highway	0.90	0.85	0.80	N/A	N/A
OR 19	Entire Section within County Limits, Outside of Cities	Regional Highway	N/A	N/A	N/A	0.75	0.70
	Within Arlington City Limits		0.90	0.85	0.80	N/A	N/A
	Within Condon City Limits		0.90	0.85	0.80	N/A	N/A
OR 74	Entire Section within County Limits	District Highway	N/A	N/A	N/A	0.80	0.75

Table 11. Intersection Performance Standards

Intersection Name	Location	Jurisdiction	Type of Intersection Control*	Performance Standard (v/c ratio)**
Walnut Street/Main Street	Condon	ODOT	TWSC	0.90 for all approaches
E Bayard Street/Main Street	Condon	ODOT	TWSC	0.90 for Main Street approaches; 0.95 for E Bayard Street approaches
I-84/Beech Street	Arlington	ODOT	TWSC	0.80 for interstate ramp approaches; 0.90 for Beech Street approaches
I-84/Locust Street	Arlington	ODOT	TWSC	0.80 for interstate ramp approaches; 0.90 for Locust Street approach
I-84/OR 74 (Eastbound Ramps)	County	ODOT	TWSC	0.70 for all movements
Cedar Springs Lane/OR 19	County	ODOT	TWSC	0.75 for Cedar Springs Lane approach movements; 0.70 for OR 19 approach movements

*TWSC = Two-way stop-controlled intersection

** v/c = volume-to-capacity ratio

Traffic Volumes

The following sub-sections discuss the weekday peak hour traffic volume development and the seasonal adjustment factor used to adjust the 2014 traffic counts.

Roadway Segment Hourly Traffic Profiles

Seven study segments were identified throughout the County. Traffic volumes were collected for 48 hours between Tuesday July 29, 2014 and Thursday, July 31, 2014. These traffic volumes were used to conduct capacity analysis to determine how the facility operates under peak hour conditions. In addition, they were used to illustrate the demand profile of the roadway by the time of day. *Appendix 4 summarizes the hourly traffic volume profiles for the seven roadway segments studied.* Based on these counts, the hour with the highest traffic volume was identified as the peak hour for that facility.

Two-lane highway capacity analysis was conducted for each roadway segment based on the peak hour traffic volumes. Table 12 summarizes the peak hour, traffic volumes, and volume-to-capacity ratio for each study segment. Although the County does not have operational targets for County facilities, the peak hour analysis reveals that all of the roadways currently operate below the roadway’s capacity.

Table 12. Roadway Segment Operations Analysis

ID	Roadway	ADT from 2014 Traffic Counts	Peak Hour Time Period	Seasonally-Adjusted Peak Hour Count	PHF*	Two-Way Demand Flow	Critical Flow Rate	Units	Calculated V/C Ratio
A	Lonerock Road, South of OR 19	173	5:00 - 6:00 p.m.	19	0.68	29	3200	pc/h	0.0092
B	Baseline Road, east of OR 19	240	9:30-10:30 am, 1:30-2:30 pm	26	0.93	29	3200	pc/h	0.0092
C	Fourmile Road, SE of OR 19	192	1:45 - 2:45 pm	28	0.65	45	3200	pc/h	0.0142
D	Blalock Canyon Road, South of I-84	142	5:15 - 6:15 pm	19	0.86	23	3200	pc/h	0.0073
E	Quinton Canyon Road, South of I-84	67	8:45 - 9:45 am	10	0.59	18	3200	pc/h	0.0056
F	Mikkalo Lane west of OR 19	145	11:45 am - 12:45 pm	16	0.78	22	3200	pc/h	0.0067
G	East Bayard Street, East of OR 19	576	10:45 - 11:45 am	55	0.68	85	3200	pc/h	0.0266

*PHF = peak hour factor

Weekday Peak Hour Development for Intersections

Traffic counts at the six study intersections were completed on Wednesday, November 19, 2014 between the hours of 5:00 a.m. and 9:00 p.m. Traffic volumes typically peak during the evening commute period, between 4:00 and 6:00 p.m. However, traffic counts at the study intersections revealed that the peak hours for some of the study intersections occurred midday or during the afternoon, due to the rural nature of the County. Based on these counts, the peak hour and peak 15-minute period within each peak hour were identified for each intersection. An intersection peak hour was used for analysis rather than a system-wide peak hour due to the long distances between study intersections throughout the County.

As summarized in the Methodology Memo (see *Appendix 3*), traffic volumes were adjusted to reflect seasonal fluctuation in traffic patterns. Exhibit 3 shows the existing intersection traffic control and lane configurations. Exhibit 4 summarizes the existing peak hour traffic volumes after seasonal adjustments were applied and the peak hour time period for each intersection.

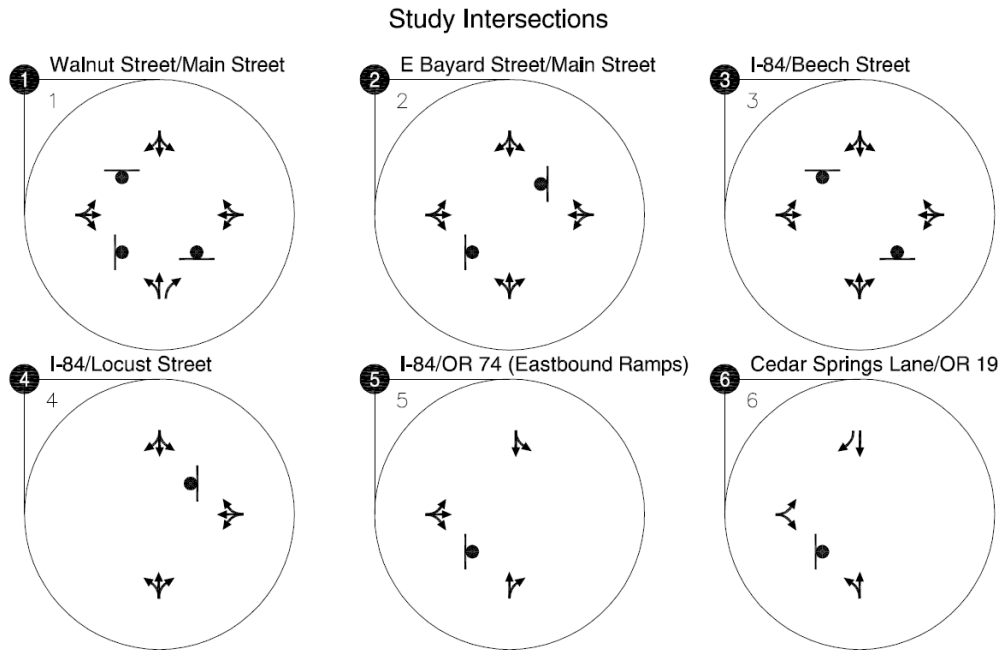

Exhibit 3. Study Intersection Traffic Control and Lane Configurations

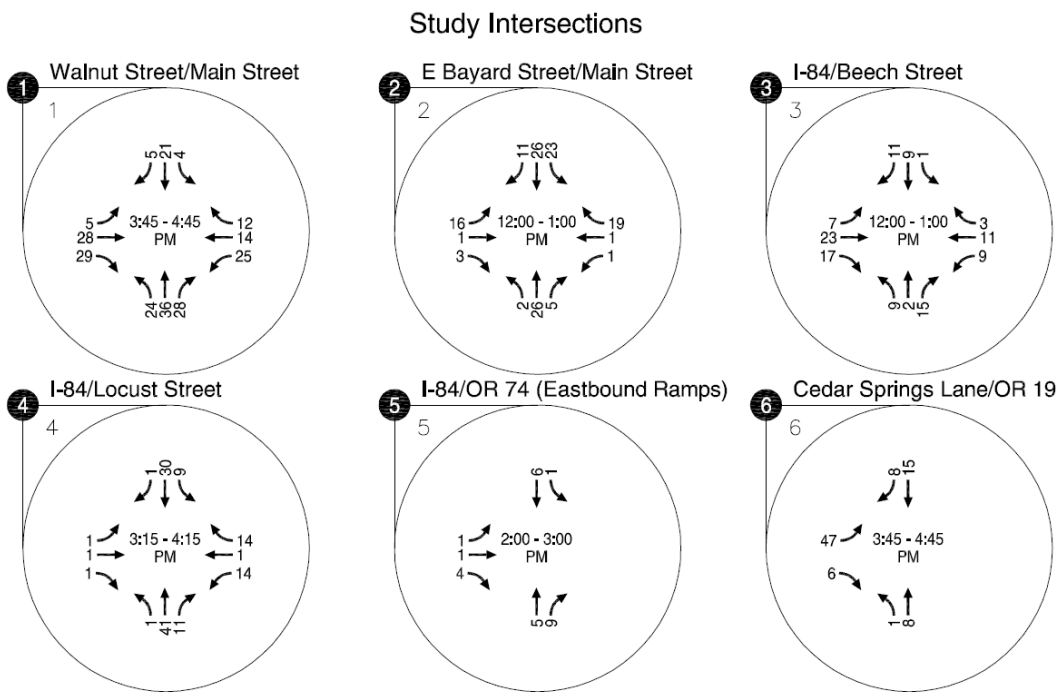

Exhibit 4. Existing Traffic Volumes and Peak Hours

Intersection Traffic Operations Analysis Results

Level-of-service (LOS), volume-to-capacity (v/c) ratios, average delay, and 95th percentile queue lengths were calculated for each of the study intersections identified for the Gilliam County TSP update. Queue lengths were calculated using ODOT’s Two-Way Stop-Controlled method, and the remaining analysis were conducted using 2010 HCM methods with Vistro and Sidra software. Table 13 summarizes the results of this analysis as well as the corresponding operational targets for the study intersections. As shown in the table, all six study intersections currently operate acceptably. The 95th percentile queue lengths reflect the maximum queue length expected during the peak 15 minutes. As shown in the table, the 95th percentile queue lengths do not exceed two vehicles in length at all study intersections.

Table 13. Intersection Operational Analysis Results

ID	Name	Critical Movement	V/C Ratio	LOS	Delay (sec)	95 th % Queue (# vehicles)	Performance Standard (v/c ratio)
1	Walnut St/Main St	WB	0.09	A	9.5	1	0.90
2	E Bayard St/Main St	EBL	0.03	A	4.2	1	0.95
3	I-84 Ramp/Beech St	SBT	0.02	A	4.8	1	0.90
4	I-84 Ramp/Locust St	EBT	0.01	A	3.0	1	0.90
5	I-84 EB Ramp/OR 74	WBL	0.00	A	2.1	1	0.70
6	Cedar Springs Ln/OR 19	EBL	0.06	A	5.9	2	0.75

Summary of Existing Traffic Conditions

Below is a summary of the major findings of the existing conditions operational analysis.

- The seven study segments currently operate with volume-to-capacity ratios well below 1.0. The highest v/c ratio was found to be 0.03.
- The six study intersections currently operate within their performance targets.
- The longest expected 95th percentile queue length was found at Cedar Springs Lane/OR 19 for the eastbound approach. This queue is expected to reach two vehicles during the peak hour.

HISTORIC CRASH ANALYSIS

Crash data from the latest five years (January 1, 2009 through December 31, 2013) was obtained from ODOT for all roadways within Gilliam County. Figure 3-7 illustrates reported crash locations throughout the state. As shown in Figure 3-7, the majority of reported crashes are located along state highways. Crash data is provided in *Appendix 6*.

County Crash Patterns

A total of 228 crashes were reported in Gilliam County between 2009 and 2013. The majority of reported crashes (147 crashes, 65%) occurred on I-84. Table 14 summarizes the reported crashes by severity. Almost half of the reported crashes involved an injury, and one crash involved a fatality. The fatal crash was reported as a fixed object, overturned crash on a curve on Lonerock Road, approximately nine miles north of the City of Lone Rock. The crash report indicates speed was a contributing factor. The weather and light conditions at the time of the crash were not reported.

Of the 13 reported severe injury crashes, seven crashes were fixed object, one was an overturn crash, one involved an animal, one involved a pedestrian, one was reported as “other non-collision”, and one was unknown. Excessive speed was reported in at least six of the 13 severe injury crashes. Alcohol was indicated as a factor in two of the reported severe injury crashes. Eleven of the 13 crashes occurred during daylight, and 11 of the crashes were reported on dry roadway conditions. The severe injury crashes were located throughout the County on the interstate, state highways, and County and local roads.

Table 14. Reported Crashes by Severity in Gilliam County (2009 – 2013)

	Crash Severity					Total
	Fatal	Injury A	Injury B	Injury C	PDO	
Number of Reported Crashes	1	13	56	38	120	228
Percentage of Total Crashes	<1%	6%	24%	17%	53%	100%

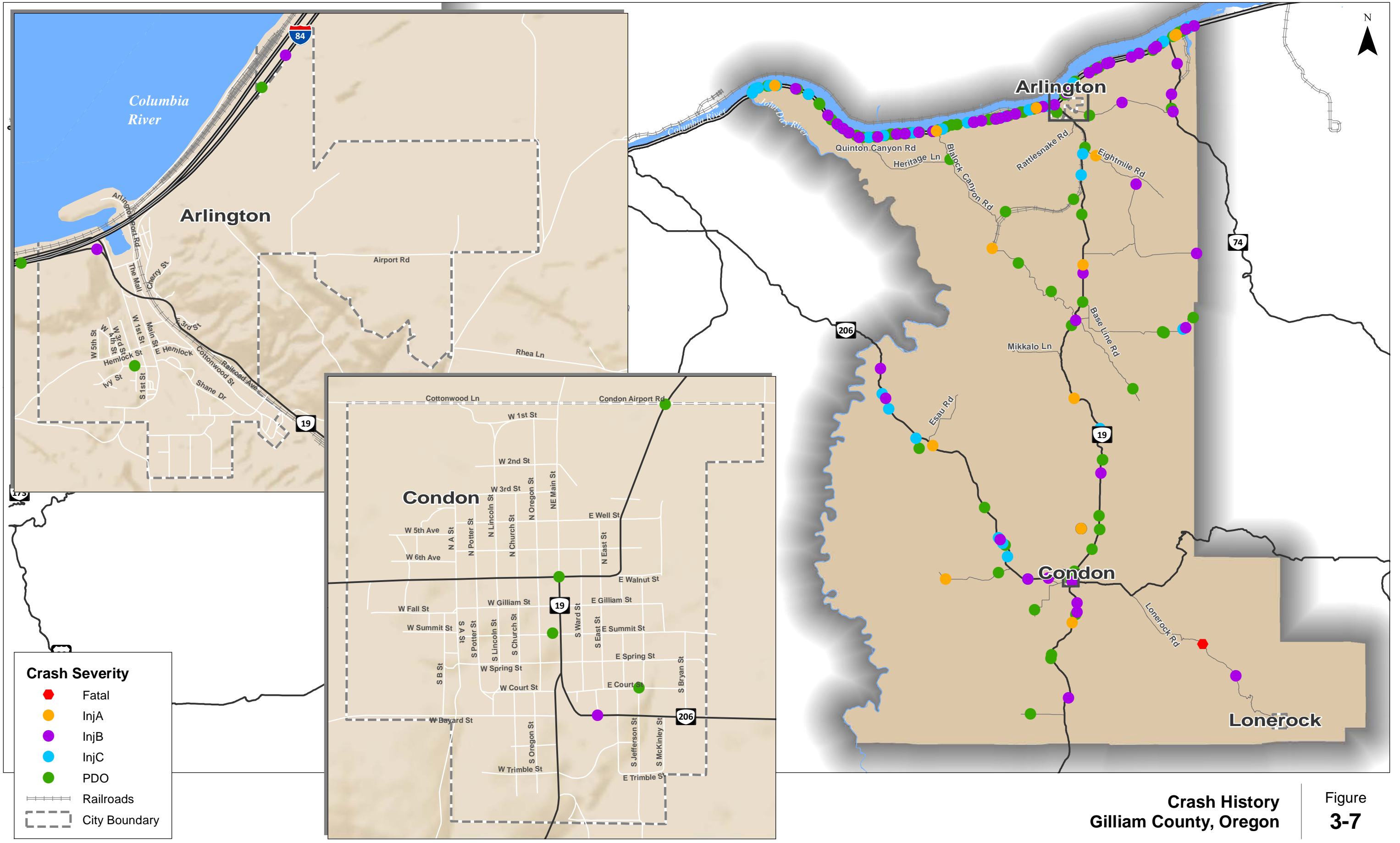

K:\H_Perland\proj\17679 - Gilliam County TSP\gis\3-8 Crash History.mxd - agriffin - 10:56 AM 11/26/2014

Exhibit 5 shows the number of crashes reported by month.

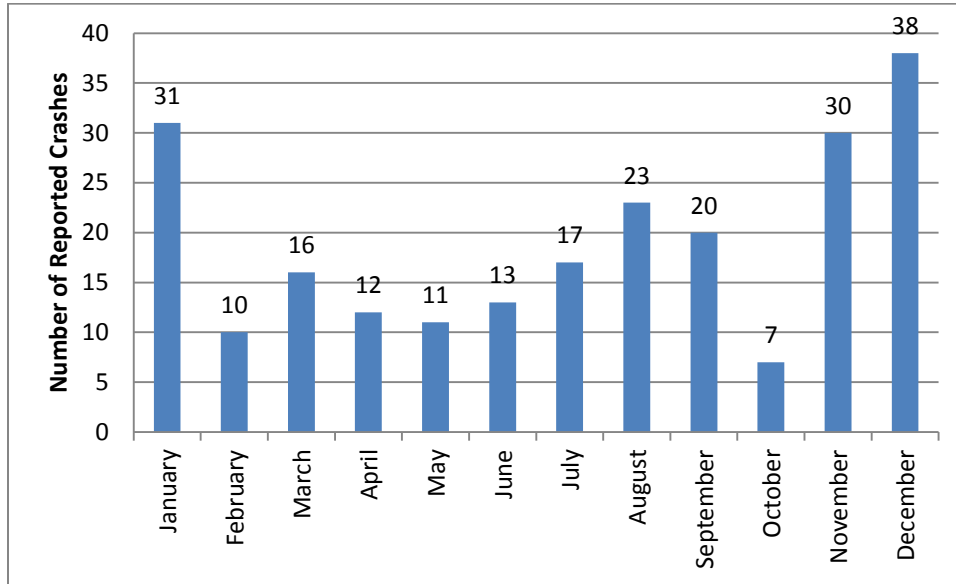

Exhibit 5. Reported Crashes by Month (2009-2013)

As shown in Exhibit 5, the highest crash frequency occurred from November through January, which typically experience inclement weather conditions producing wet, icy, and/or snowy conditions. Further review of crashes in November, December, and January (99 crashes) indicate that 80% (79 crashes) occurred on roadway surfaces that were wet, icy, or snow-covered. Just over 50% (51 crashes) occurred in dark, dawn, or dusk lighting conditions.

Over the study period, almost 70% of crashes (156 crashes) were reported as fixed object or non-collision crashes. Over 41% (94 crashes) occurred on roadway surfaces that were wet, icy, or snow-covered. The same number (94 crashes) occurred in dark, dawn, or dusk lighting conditions. One reported crash on I-84 involved a pedestrian in the western end of the County during icy roadway conditions.

Of the 81 crashes that occurred on non-interstate facilities, 47 crashes (58%) occurred on rural minor arterials, 14 crashes (17%) occurred on rural major collectors, 2 crashes (3%) occurred on rural minor collectors, and 18 crashes (22%) occurred on rural local streets or roads.

Intersection and Segment Crash Analysis

Study intersections and segments were analyzed individually and compared to statewide averages for similar facilities, when possible.

Reported crashes at study intersections are summarized in Table 16. Several of the study locations did not experience any crashes during the five-year study period. Intersection exposure was measured in terms of total entering vehicles (TEV), derived from the peak hour volumes used in the intersection

operational analysis. The peak hour was assumed to be ten percent of the daily volume. ODOT identifies 90th percentile crash rates in the Analysis Procedures Manual, Exhibit 4-1 (Reference 3). These crash rates are presented in Table 16. The ODOT APM indicates that intersections that exceed the 90th percentile should be further analyzed. None of the study intersections in Gilliam County exceed their corresponding 90th percentile crash rates.

Table 16. Reported Crashes at Study Intersections

Intersection Name	# of Crashes	TEV	Crash Rate	90 th Percentile Crash Rates	Crash Type					Severity		
					Angle	Rear-End	Turning	Fixed-Object	Other	PDO	Injury	Fatality
Walnut Street/Main Street	1	230	0.238	0.408	1	0	0	0	0	1	0	0
E Bayard Street/Main Street	0	135	0	0.293	0	0	0	0	0	0	0	0
I-84/Beech Street	0	118	0	0.408	0	0	0	0	0	0	0	0
I-84/Locust Street	0	125	0	0.293	0	0	0	0	0	0	0	0
I-84/OR 74 (Eastbound Ramps)	0	28	0	0.475	0	0	0	0	0	0	0	0
Cedar Springs Lane/OR 19	0	86	0	0.475	0	0	0	0	0	0	0	0

¹TEV = Total entering vehicles

²PDO = Property damage only

³Crash Rate = Crashes per million entering vehicles

Reported crashes along study roadway segments are summarized in Table 17. Exposure on the segments was measured based on ADT calculated from 2014 24-hour volume counts. ODOT publishes statewide average roadway segment crash rates for the past five years for urban and rural areas, by functional classification. The statewide average roadway segment crash rates for rural minor collectors are provided in Table 17 for comparison to calculated crash rates for highways in Gilliam County. Although two segments (Quinton Canyon Road and E Bayard Street) exceed the statewide average, these are both short segments with only one crash reported during the most recent five years.

Table 17. Reported Crashes at Study Roadway Segments

ID	Segment Name	Segment Boundaries	Segment Length (miles)	Number of Crashes	ADT	Crash Rate (2009 – 2013 average)	State Average	Crash Type		Severity		
								Fixed-Object	Other	PDO	Injury	Fatality
A	Lonerock Road	Between OR 206 and Lone Rock	14.5	2	173	0.437	1.586	1	1 (Non-Collision)	0	1	1
B	Baseline Road (including Lone Road)	Upper Fourmile Road	10.5	6	240	1.305	1.586	4	2 (Non-Collision)	4	2	0
C	Fourmile Road	Between OR 19 and Eightmile Canyon Road	4.7	1	192	0.607	1.586	0	1 (Non-Collision)	0	1	0
D	Blalock Canyon Road	I-84 to Heritage Lane	2.5	1	142	1.544	1.586	1	0	1	0	0
E	Quinton Canyon Road	I-84 to Heritage Lane	1.25	1	67	6.543	1.586	0	1 (Non-Collision)	0	1	0
F	Mikkalo Lane	OR 19 to Mikkalo	2.0	0	145	0.000	1.586	0	0	0	0	0
G	E Bayard Street	OR 19 to East City Limit	0.5 miles	1	576	1.903	1.586	0	1 (Head-On)	0	1	0

Findings from the crash analysis indicate the following:

- Baseline Road, which becomes Lone Road several miles east of OR 19, has the highest crash frequency among the study segments.
- Over 70% of reported crashes in the County occurred on the interstate.
- Over 41% of reported crashes in the County occurred on a wet, icy, or snowy roadway.
- Many of the crashes indicated speed too fast for conditions as a contributing cause.
- Among the severe injury crashes, the majority were single-vehicle crashes. Speed was a contributing factor in approximately half of the reported severe injury crashes. Roadway conditions and lighting were not prevalent factors among the reported severe injury crashes.
- Although individual locations were not identified as issue areas, the prevalence of single-vehicle, speed-related, and weather-related crashes may indicate potential opportunities for low-cost systemic safety improvements throughout the County.

- ODOT identified several sections of the John Day Highway (OR 19) and Wasco-Heppner Highway (OR 206) in Gilliam County in their Roadway Departures Plan. The Plan recommends edgeline rumble strips, where possible with the shoulder width, at those identified locations, and centerline rumble strips for every state highway in the County. The locations where edgeline rumble strips were recommended include:
 - OR 19: MP 15.91 – 16.48
 - OR 19: MP 17.05 – 17.61
 - OR 19: MP 17.61 – 18.18
 - OR 19: MP 21.59 – 22.16
 - OR 206: MP 17.61 – 18.18
 - OR 206: MP 30.68 – 31.25
 - OR 206: MP 35.23-35.80

Statewide Priority Index System (SPIS)

ODOT developed the Safety Priority Index System (SPIS) to identify and prioritize sites where countermeasures could be implemented to potentially reduce the number of crashes. No segments or intersections within Gilliam County were identified in the top ten percent of the 2013 and 2012 SPIS lists (which use crash data from 2009 to 2011, and 2010 to 2012, respectively). The 2011 SPIS list includes one site on I-84, east of the interchange with OR 74, in the 90th – 95th percentile list.

Based on the 2009 to 2013 crash data, eight crashes were reported on I-84 along the approximately one-mile long segment between the interchange with OR 74 and the eastern County border. Four of the crashes occurred in the eastbound direction, and four crashes occurred in the westbound direction. The road character for three of the crashes in the eastbound direction was reported as a vertical curve. Six of the crashes were reported as fixed object crashes, one was a rear-end crash, and one was an animal crash. One crash occurred on a wet roadway, one occurred in snow conditions, and the remaining six crashes occurred on dry pavement in clear weather. The crash reports indicated that driver fatigue contributed to three crashes, inattention and improper driving contributed to two crashes, speed too fast for conditions contributed to one crash, tire failure contributed to one crash, and following too closely contributed to one crash. Five crashes were logged at milepost 148.0, including a fatal crash that involved drugs. These five crashes likely contributed to the location making the SPIS list; ODOT proposed to monitor the site in the future.

Sight Distance and Major Design Deficiencies

Operational analysis and safety analysis reflect the transportation deficiencies identified in data. However, some geometric or observed issues may reflect opportunities for treatments before data indicates an issue. These may be due to inadequate sight distance or other design details. The

following were identified as potential locations that will be reviewed during the site visit on December 3, 2014:

- The intersection of Walnut Street & Main Street in Condon: The four-way intersection is 3-way stop-controlled. Confusion among drivers has been observed by residents; drivers at the intersection do not always realize one leg of the intersection is not stop-controlled. The County is interested in treatments at this location.
- Congestion often forms from truck traffic at the Port when farm and commercial haulers try to access the elevator.
- Railroad crossings in Arlington cause traffic to back-up on the interstate ramps and within Arlington. The trains have been observed stopping on the tracks for relatively long periods of time. During this time, emergency vehicles cannot access the interstate or travel around town as congestion forms.
- The intersection of Lone Rock Road/OR 206 is located on a curve and at an angle, potentially causing sight distance concerns.

Note: This section will be finalized and expanded upon after the site visit.

PEDESTRIAN AND BICYCLIST SYSTEM

The pedestrian and bicyclist system for Gilliam County are summarized in Figure 3-8 and Figure 3-9, respectively. The inventory was completed based on ODOT's data for state facilities and a review of the downtown areas using Google Earth aerial imagery. No sidewalks or bicycle facilities are located within the City of Lonerock.

The pedestrian facilities inventory map in Figure 3-8 shows the location of existing sidewalks and crosswalks within the downtown areas of Condon and Arlington. As shown in the figure, sidewalks are located along the downtown commercial cores of both cities, but the sidewalks are discontinuous beyond the downtown cores. Schools in both cities are connected to the downtown commercial cores by continuous sidewalks and crosswalks. In Condon, the elementary school and high school locations are also connected by sidewalks and crosswalks. Residential areas are not connected to schools and commercial areas by continuous sidewalks.





The bicyclist facilities shown in Figure 3-9 were obtained from ODOT's inventory of bicycle facilities. In Arlington, these facilities are primarily striped shoulders that can be used by bicyclists. In Condon, the roadways are wide and provide adequate space for bicyclists although no marked bicycle lanes are present. Within the downtown areas, no bicyclist facilities are provided on non-state facilities. The local, lower speed and lower volume residential streets are typically not marked for bicyclists as the bicyclists can share the roadway with the slower vehicles.

Gilliam County is also a popular recreational bicycling location for bicyclists from around the state who are attracted by the scenery and low traffic roads. The John Day River Territory is a popular

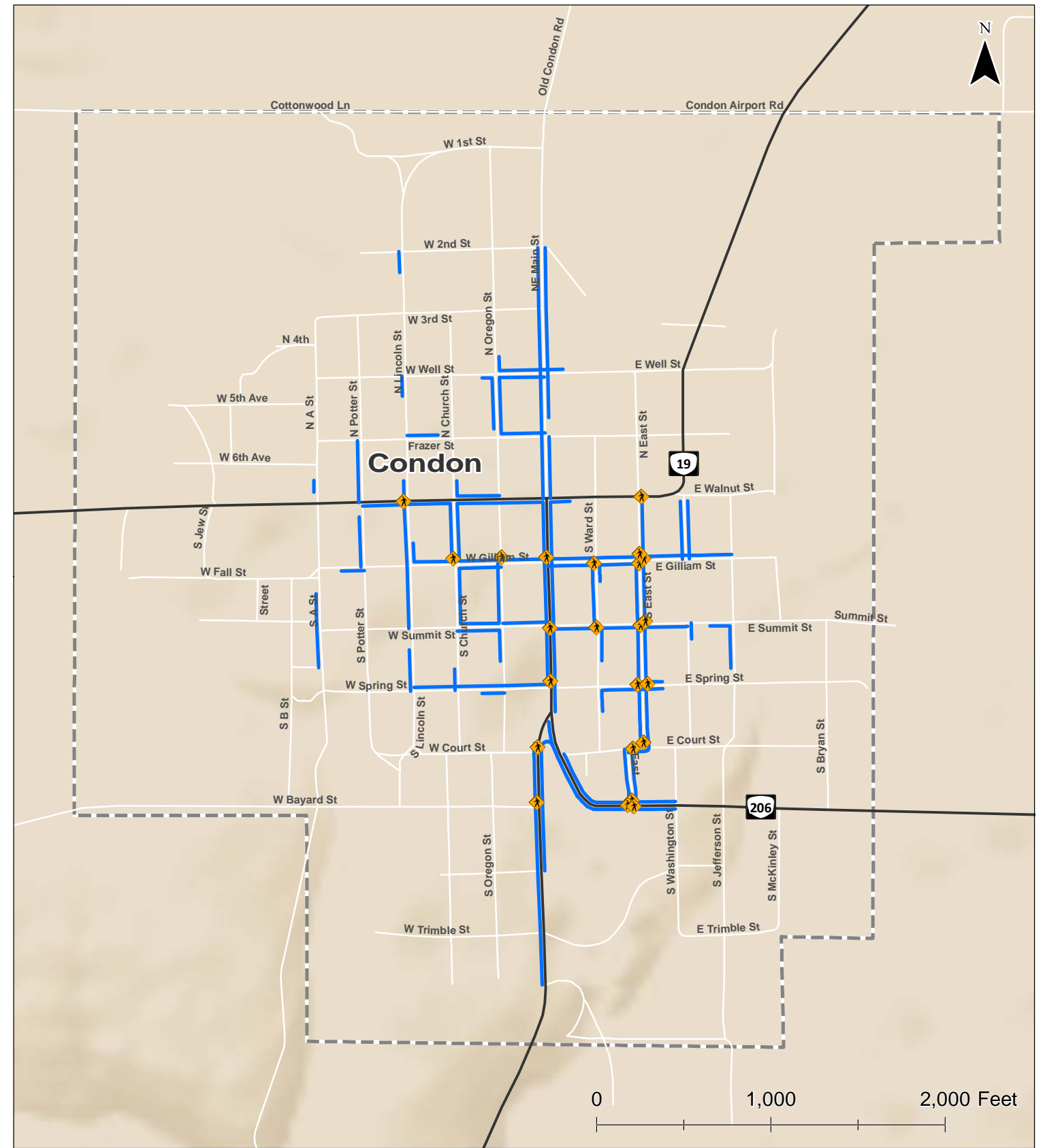
attraction. Many of the roadways are low volume, gravel roadways and scenic roadways. Popular recreational routes include OR 19 south of Condon to Fossil, OR 206 west of Condon to Wasco, and OR 206 east of Condon to Heppner. Bicyclists are not as common between Condon and Arlington. The majority of these routes have minimal shoulders and rough pavement conditions. In addition, there are no commercial or public locations on these routes, with the exception of the new Cottonwood State Park located off of OR 206 on the ride to Wasco, for bicyclists to stop and hydrate on the ride.

DRAFT







-  Crosswalks
-  Sidewalks
-  Railroads
-  City Boundary

**Pedestrian System Inventory
Gilliam County, Oregon**

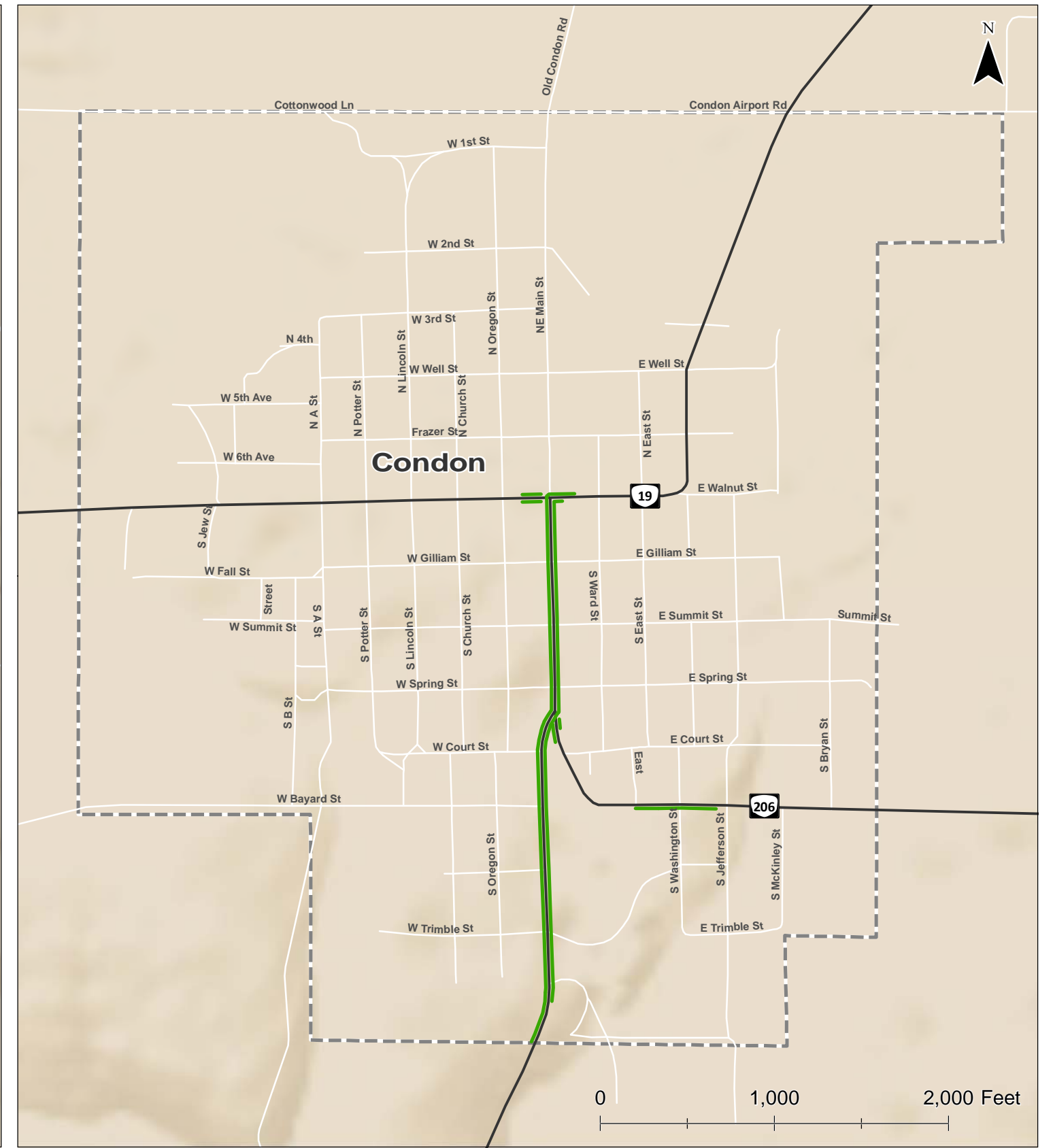
**Figure
3-8**

K:\H_Perland\proj\17679 - Gilliam County TSP\gis\3-9 Pedestrian System Inventory.mxd - agriffin - 10:59 AM 11/26/2014



-  Bicycle Facilities
-  Railroads
-  City Boundary

**Bicycle System Inventory
Gilliam County, Oregon**

**Figure
3-9**

K:\H_Perland\proj\17679 - Gilliam County TSP\gis\3_10 Bicycle System Inventory.mxd - egr\lin - 11:01 AM 11/26/2014

PUBLIC TRANSPORTATION SYSTEM

Gilliam County Special Transportation (GCST) operates dial-a-ride transit service for the County. The service provides approximately 10,000 trips each year. No fixed route service exists within the County.

GCST operates eight vehicles, with five in Condon and three in Arlington. Service was recently expanded to include a vehicle in Lonerock. The County sold one ADA bus due to expensive repairs and needs to replace the bus with a smaller vehicle that includes an easy-to-operate wheelchair device that does not require the assistance of volunteers, who are often elders. Two of the remaining vehicles are accessible, and all vehicles are driven by a team of 21 volunteers. Two additional volunteers live in Lonerock and provide rides between Lonerock and Condon, where residents can catch another vehicle going to their final destination. When drivers are unavailable, the GCST director is sometimes required to drive the vehicles. There are no part-time dispatch staff currently available to cover these occasions when the director, who also functions as the dispatcher, must leave. The County has expressed interest in a carport at the Lonerock community center to protect the vehicle year-round and an expanded garage or similar facility in Condon to keep vehicles clear year-round.

The dial-a-ride service may be used by the general public for any purpose. About 80 percent of the trips serve seniors or people with disabilities. Residents are asked to call 36 hours in advance to schedule their trip. Rides are available Monday through Friday from 7:00 a.m. to 6:00 p.m., although some longer distance medical trips extend beyond these hours. Most trips are for medical purposes (90 percent), shopping, social, or business purposes. There is often a need for volunteer caregivers to ride along with passengers to provide assistance to the passengers traveling to medical appointments. The nearest medical facilities are located in either The Dalles or Hermiston. Frequent trips are also made to Portland for OHSU.

GCST is funded through grants, donations, and medical mileage reimbursement programs. GCST has expressed the need for more maintenance money to cover tires, snow tires, brake repairs, etc. There is currently no funding for training for the defensive driving passenger assistance training required for volunteers by the transportation brokerage. The Gilliam County Transportation Services Director is interested in becoming certified to provide this training to volunteers from Gilliam County and other nearby counties. Riders are not charged a fee, but suggested donations are recommended and vary from \$2 to \$30 depending on the length of the trip, purpose of the trip, and type of vehicle used. Veterans often must travel longer distances for their services and are not asked to provide donations for their ride. The County lacks existing funding for drivers to take veterans to hospitals and wait until the following day to bring veterans back from procedures.

TRUCK FREIGHT ROUTES

I-84 is the only state facility in Gilliam County designated as a state truck freight route, as shown in Figure 3-10. National and regional truck freight movements are intended to occur via I-84, which is

part of the National Highway System. Although not designated as a state truck freight route, OR 19 also carries local and regional truck traffic, particularly between the landfill and I-84 in Arlington.

DRAFT

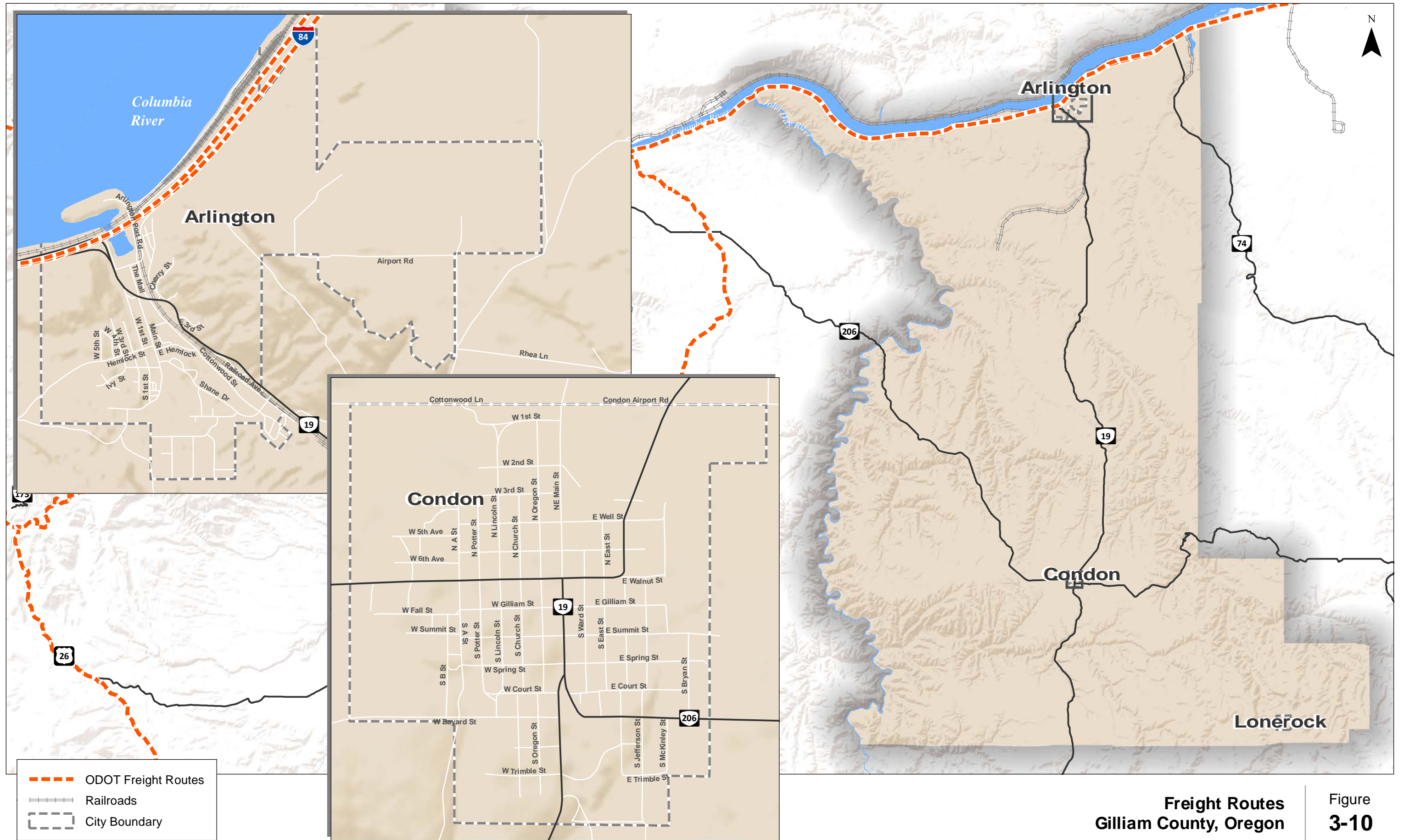

**Freight Routes
Gilliam County, Oregon** | **Figure
3-10**

K:\H_Perland\proj\17679 - Gilliam County TSP\figs\3-10 Freight Routes.mxd - agriffin - 11:03 AM 11/26/2014

RAIL SYSTEM

Union Pacific (UP) provides freight rail service through Gilliam County. There is currently no passenger rail service in the County. UP Rail lines follow I-84 and the Columbia River and provide access to Portland and the Hinkle Railyard in Hermiston.

Rail service is also available between Arlington and the Columbia Ridge Landfill and Recycling Center, located approximately 10 miles south of the primary Columbia River line in Arlington. The landfill receives solid waste by rail from major metropolitan areas up and down the west coast, and that traffic keeps operations over the remnant of the line healthy. All trains on the branch are operated by Watco through their Palouse River and Coulee City Railroad. The Watco line is a Class III or short-line railroad which has an annual operated revenue of less than 20 million dollars (1991 dollars). Class III railroads are typically local short-line railroads serving a small number of towns and industries or hauling cars for one or more larger railroads. The only materials shipped by rail currently are solid waste from metro areas. Six unit trains run on this branch per week. The train speed from I-84 to the end of the line at the Columbia Ridge Landfill and Recycling Center is 25 mph. The track is in good condition with regular maintenance conducted.

There are two crossings within the City of Arlington that are associated with issues. When the trains cross the roadways, there are times when the train is stopped or traveling at slow speeds, prohibiting emergency vehicles from accessing OR 19 and I-84. Additionally, traffic entering Arlington westbound can back up on the I-84 exit to the interstate.

Additional rail connections were abandoned in 1993. The 44-mile long railroad between Arlington and Condon was completed in 1905 from a junction with the mainline at Arlington south to the agricultural town of Condon. The Columbia River & Oregon Central Railroad built the line with the financial backing of the Union Pacific, who assumed ownership of the line after it was completed. Traffic over the line was primarily agricultural until 1928, when the Condon Kinzua & Southern completed its line from Condon south to Kinzua, OR. Forest products off of the CK&S became the primary source of traffic handled until 1978, when the big sawmill in Kinzua closed and the short line was abandoned. The decline of carloadings received from the CK&S prompted UP to close the Condon depot in 1975.

Agricultural traffic, primarily grain, kept the trains running to Condon through the late 1980's. By the early 1990's operations over the line were non-existent, and UP applied to abandon the line. The only remaining shipper on the line, Condon Grain Growers, argued against the abandonment, stating that UP's inability to guarantee a certain number of cars during the past two years prevented it from loading any cars. The ICC rejected this argument with the comment that a problematic car supply did not explain why nothing had been shipped over the railroad in 18 months. UP's last run to Condon took place in late summer 1992, when some light engines made the long run up the branch to retrieve a cut of grain hoppers ordered but never loaded by Condon Grain Growers. The ICC granted permission to abandon the line in September 1992, and the rails were removed in 1993. A little over eleven miles of the branch remains in place today, from Arlington to Columbia Ridge Landfill.

The 33 miles of abandoned railroad may be reviewed and considered for rails-to-trail opportunities to create shared-use paths for pedestrian and bicyclist travel in the County, if connections can be created for the 11-mile section to Arlington that is still served by active rail.

The County prioritizes maintaining the 10-mile connection to the Columbia Ridge Landfill and Recycling Center. If the railroad that allows unit-trains to haul solid waste to Columbia Ridge Landfill and Recycle Center were to be discontinued, the adverse impacts I-84, OR 19 and Cedar Springs Road would be substantial. The average intermodal rail container carrying solid waste from Seattle to CRLRC has a large tonnage capacity. With six unit trains currently operated per week, many trucks would be added to the road system with the potential for increased wear and tear on the roadways, increased air pollution, and increased risk for crashes involving trucks.

AIR TRANSPORTATION SYSTEM

Gilliam County has two general aviation airports. One airport is located in Arlington, and the other is in Condon. This section describes the two existing airports.

Arlington Airport

Arlington Municipal Airport (FAA LID: 1S8) is a non-towered public airport located one mile northeast of the central business district of Arlington. It is owned by the City of Arlington and was activated in December 1943. Arlington Municipal Airport covers an area of 80 acres (32 ha), including one runway with a gravel and dirt/turf surface measuring 5,000 x 50 feet (1,524 x 15 m). The runway was reported in poor condition in 2013, due to bunchgrass growth. The elevation at the Arlington Airport is 890 feet/271.3 meters. There are no general aviation services at the Arlington Municipal Airport with the exception of parking tie downs for aircraft. The Arlington Municipal Airport has municipal water and sewer available on adjacent Arlington Mesa Industrial Park along with Fiber Optic Conduit.

Aircraft operations averaged 76 per month for a 12 month period ending May 20, 2014 and consisted of 55% local general aviation, 44% transient general aviation, and 1% air taxi. Insitu uses the airport as a testing location for Unmanned Aerial Vehicles (UAVs) and has a dedicated structure on Airport property. According to the 2007 Oregon Aviation Plan, the Arlington Municipal Airport is considered a *Category V – Remote Access/Emergency Service Airport*.

The Arlington Municipal Airport is located in the Enterprise Zone within the City Limits of Arlington and is Zoned M1 and M2 (industrial) with an Airport Development (AD) overlay zone (AD). The Airport is adjacent to the Arlington Mesa Industrial Park. The surrounding uses in the immediate area are agricultural and industrial nature with residential uses in the City of Arlington and I-84 within one mile but separated by steep terrain.

Condon Airport

Condon State Airport (Pauling Field) is located approximately one-mile northeast of the City of Condon. Regionally, the Airport is located approximately 150 miles east of Portland and 140 miles north of Bend. OR 19 provides access to the Airport and also provides a critical ground transportation link to eastern Oregon and to the rest of the state.

Condon State Airport was constructed by the Board of Aeronautics in 1953. The Airport is owned and operated by the State of Oregon Department of Aviation (ODA) and is included in the National Plan of Integrated Airport Systems (NPIAS), making this airport eligible for federal funding. Condon State – Pauling Field, designated by the airport code 3S9, occupies approximately 103 acres of land. According to the 2007 Oregon Aviation Plan, the Condon Airport-Pauling Field is considered a Category IV – Local General Aviation Airport. The airport is located at an elevation of 2,911 feet/887.3 meters.

The Condon State Airport plays a supportive role in the current system, providing geographic coverage and access to the state's airport system. The airport also serves as a base for agricultural spraying operations. Aircraft operations averaged 76 per week in the 12 month period ending February 05, 2013. Of these, 76% were transient general aviation, 22% were local general aviation, and 2% were air taxi.

The airfield consists of many components that are required to accommodate safe aircraft operations. This consists of runways, taxiways, and an apron network; the visual and electronic navigational aids associated with runways; runway protection zones; and general aviation facilities.

With assistance from the FAA in 1986, the Aeronautics Division rebuilt the airport with improved runway alignment. The airport has a single paved runway, Runway 07-25. The runway is 3,500 feet long and 60 feet wide with a concrete surface. The Airport currently has an Airport Reference Code (ARC) of B-I. The existing taxiway system at the Airport consists of two connecting taxiways from the hangar and apron areas to the runway. Aircraft turnarounds are located on both runway ends. There is one apron used for aircraft parking. The apron has 10 small aircraft tie down spaces. The apron is constructed of asphalt.

There are no general aviation services nor fueling facilities at the Airport. Hangar space at the Airport is comprised of limited T-Hangars located adjacent to the apron area. There are 13 hangar facilities at the Airport. Vehicle parking is located adjacent to the apron area. There are approximately 10 parking spaces in this location. In addition, there are vehicle parking spaces available next to each hangar.

The Airport's lighting and navigational systems extend the Airport's usefulness into night and/or poor visibility. Pavement edge lighting consists of light fixtures located near the edge of the runway/taxiway to define the lateral limits of the pavement. This lighting is essential for the safe and efficient movement of aircraft during periods of darkness or poor visibility. Runway 07-25 is equipped with medium intensity runway lighting (MIRL). A four-light precision approach path indicator (PAPI) is

installed on both runway ends. A PAPI is a system of either two or four identical light units that provide pilots with either red, white, or a combination of red/white lights which indicate whether a pilot is below, above, or on the glide path to the runway. Runway end identifier lights (REILs) consist of two synchronized flashing lights located near the runway threshold which provide rapid and positive identification of the approach end of a runway. REILs help pilots identify the end of a runway especially when other light sources obscure other runway lighting. REILs are installed on both runway ends.

INTERMODAL CONNECTIONS

Intermodal connections for passenger service exist in the form of transit, pedestrian and bicycle, and automobile connections. Intermodal connections for freight exist in the form of rail, truck, air, and water transport connections. This section describes those connections.

Freight Transportation

Industrial activities are important economic catalysts in Gilliam County, with energy, waste management, and agriculture being key industries in the County. Therefore, the intermodal connections for freight are important for the County.

The Port of Arlington supports economic development and intermodal transportation connections that include rail, highway, and marine transportation. The Port owns 30 acres located at the Arlington Mesa Industrial Park and provides a Barge Facility for river access.

The landfill site and several industrial sites south of Arlington are connected to the rail line that runs between Arlington and the landfill. In addition, OR 19 serves these industrial sites south of the City. OR 19 and the rail service connect up to the Port of Arlington. Additionally, the City has developed an industrial zoned area around the airport to encourage supporting land uses in this area.

In Condon, rail service no longer exists. However, the City's industrial lands are primarily located in the northeast area of the City, in close proximity to OR 19 for freight transportation and the Condon airport.

Passenger Transportation

The ODOT Region 4 Park and Ride Plan reviewed existing park and ride lots throughout the Region and recommended priority locations for new lots and/or upgrades to existing lots. There are no formal park and ride lots in the County, but there are several informal lots located in the County:

- Earl Snell Park, Arlington: The lot is used for some carpooling for commuting and for medical or shopping trips. There is unpaved, unused area on the west side of the park that

could be developed as a park and ride lot. This area is also adjacent to the downtown core of Arlington, which contains connected sidewalks for pedestrians.

- Gravel pull-out lot at Clem-Mikkalo Road and OR 19: This lot serves people traveling from Condon to Arlington and The Dalles.
- Bus Barn in Condon
- St. Johns Catholic Church in Condon
- United Church of Christ in Condon
- Bank of Eastern Oregon in Arlington

The demand for park and ride lots was determined to be medium to low based on stakeholder interviews conducted as part of the plan. The lower priority designation is due to the fact that the area is relatively rural and there is abundant parking available to be used informally as a park and ride lot.

The interviews revealed that the highest demand for park and ride lots in the County is for travel to the Arlington area by employees of Waste Management and the Shepherds Flat Wind Farm. The interviewees indicated that the west end of Earl Snell Park in Arlington had the greatest potential for becoming a park and ride lot. Beyond upgrading existing informal park and ride lots, the interviewees indicated there is no need for additional park and ride lots. Carpooling, vanpooling, and transit can also be used to serve the demand. Upgrades to existing informal lots should consider pedestrian and bicycle connectivity to support bike tourism in the County.

BRIDGE CONDITIONS

ODOT maintains an inventory of bridge conditions within the County, as summarized in Table 18. Table 18 includes State, County, and City owned facilities. One bridge on Lonerock Road currently has a load restriction posted, and one bridge on Cayuse Canyon Road is currently closed to all traffic.

Sufficiency rating is a measure between 0 and 100 calculated by the Federal Highway Administration (FHWA), based on factors such as condition, materials, load capacity, and geometry (i.e., dimensions). FHWA uses the rating as a tool to prioritize the allocation of funds for bridge repairs. In general, bridges with a sufficiency rating of less than 50 are given priority. The sufficiency rating is used to identify deficiencies, which may include structural issues or functional issues. For example, older bridges may be narrow and not designed to the same width or height clearance of today's standards. Therefore, a sufficiency rating does not necessarily indicate a structural issue.

There are two bridges with sufficiency ratings below 50 within Gilliam County: the Cayuse Canyon Road bridge over Rock Creek, which is currently closed to traffic, and the I-84 Eastbound bridge over Willow Creek at milepost 148.6. Although the Lonerock Road bridge is posted for load, it has a sufficiency rating of 57. The I-84 bridge is a state owned facility, while the Cayuse Canyon Road bridge is a County facility. The I-84 bridge is too narrow to accommodate the adjacent highway facilities,

which is why the bridge is given a low sufficiency rating. However, the bridge is structurally sufficient. The closed County bridge on Cayuse Canyon Road is structurally deficient and may need repairs or replacement before it could be reopened.

DRAFT

Table 18. Gilliam County Bridge Inventory

Bridge ID	Owner	Year Built	Length (ft)	Carries	Crosses	MP	Sufficiency Rating	Posting	Operating Load	Inventory Rating (tons)
00108B	ODOT	1963	1540	I-84 (HWY 002)	JOHN DAY RIVER	114.6	76.5	A Open, no restriction	60	36
00795A	ODOT	1982	42	OR 19 (HWY 005)	JUNIPER CANYON	19.25	91.8	A Open, no restriction	71	43
00906A	ODOT	1979	163	OR 74 (HWY 052)	WILLOW CREEK	3.94	88.9	A Open, no restriction	34.3	26.5
01103A	ODOT	1972	475	OR 19 (HWY 005)	THIRTYMILE CR	43.92	83.7	A Open, no restriction	98	24
01792	ODOT	1934	99	OR 206 (HWY 300)	ROCK CREEK	51.67	84.8	A Open, no restriction	48	35
03456	ODOT	1995	25	OR 19 (HWY 005)	CHINA CREEK	4.03	93.6	A Open, no restriction	60	36
07520A	ODOT	1954	292	I-84 (HWY 002) WB	WILLOW CREEK WEST	148.57	51.3	A Open, no restriction	21.2	16.4
08820	ODOT	1964	1463	I-84 (HWY 002)	ARLINGTON VIADUCT	137.91	78	A Open, no restriction	60	36
08944	ODOT	1964	188	PHILLIPI CANYON RD	I-84 (HWY 002)	123.31	79.5	A Open, no restriction	43	26
08945	ODOT	1964	157	I-84 (HWY 002)	BLALOCK CANYON RD	129.43	84.1	A Open, no restriction	30.7	23.7
09126	ODOT	1964	204	OR 74 (HWY 052)	UPRR	3.21	95.4	A Open, no restriction	44.8	34.6
09168	ODOT	1964	69	OR 19 (HWY 005)	CHINA CREEK	0.58	88.6	A Open, no restriction	45	27
09170	ODOT	1964	30	OR 19 (HWY 005) CO	CHINA CREEK	0.73	93.9	A Open, no restriction	53	32
09197	ODOT	1965	340	I-84 (HWY 002) EB	WILLOW CREEK EB	148.6	33.3	A Open, no restriction	16.8	13
09198	ODOT	1964	258	OR 74 (HWY 052)	I-84 (HWY 002)	0.31	70	A Open, no restriction	24.5	18.9
13567	ODOT	1972	22	OR 19 (HWY 005)	CONDON CANYON CR	43.23	90.1	A Open, no restriction	60	36
13568	ODOT	1972	22	OR 19 (HWY 005)	CONDON CANYON CR	43.36	98	A Open, no restriction	60	36
13569	ODOT	1972	22	OR 19 (HWY 005)	CONDON CANYON CR	43.62	98.1	A Open, no restriction	60	36
19893	ODOT	2005	135	OR 19 (HWY 005)	ROCK CREEK (OLEX)	17.03	81.9	A Open, no restriction	30.8	23.8
21C01	Gilliam Co.	1987	71	RHEA ROAD	WILLOW CREEK EB	0.05	98	A Open, no restriction	98	59
21C02	Gilliam Co.	1991	72	MORRIS ROAD	ROCK CREEK	0.01	99	A Open, no restriction	70	42
21C03	Gilliam Co.	1987	27	FRENCH CHARLE ROAD	ROCK CREEK	4.5	98	A Open, no restriction	98	56
21C04	Gilliam Co.	1965	82	CAYUSE CANYON ROAD	ROCK CREEK	4	31.9	K Closed to all traffic	14	8
21C05	Gilliam Co.	1958	69	FOURMILE ROAD	EIGHTMILE CREEK	4.93	95.9	A Open, no restriction	68	41
21C06	Gilliam Co.	1960	40	BASLINE RD	EIGHTMILE CREEK	9.47	85.9	A Open, no restriction	43	28
21C07	Gilliam Co.	1957	63	BARNETT RD	ROCK CREEK	8.38	88.4	A Open, no restriction	44	26
21C08	Gilliam Co.	1962	81	UPPER ROCK CR ROAD	ROCK CREEK	3	94.8	A Open, no restriction	53	32
21C09	Gilliam Co.	1967	111	WOLF HOLLOW LANE	ROCK CREEK	5	96.2	A Open, no restriction	57	34
21C10	Gilliam Co.	1958	71	LONE ROCK ROAD	LONE ROCK CREEK	0	57	P Posted for load	38	23
21C12	Gilliam Co.	1960	100	ROCK CREEK ROAD	ROCK CREEK	9.3	94	A Open, no restriction	52	31
21C13	Gilliam Co.	1964	81	MIKKALO LANE	HAY CREEK	0	90.9	A Open, no restriction	68	41
21C14	Gilliam Co.	1957	63	TRAIL FORK ROAD	THIRTYMILE CREEK	2.5	89.9	A Open, no restriction	47	28
21C15	Gilliam Co.	1973	34	MIKKALO LANE	SCOTT CANYON CREEK	2.5	96	A Open, no restriction	77	46
21C16	Gilliam Co.	1973	34	ROCK CREEK ROAD	JUNIPER CANYON CREEK	0.1	96.9	A Open, no restriction	79	48
22190	Gilliam Co.	2013	28	ALVILLE LANE	FERRY CANYON CREEK	1	78	A Open, no restriction	75	45
21521	City of Arlington	1954	35	Port Access Road	CHINA CREEK	0	91.5	A Open, no restriction	90	54
01100A	ODOT	1972	8	OR 19 (HWY 005)	DRY GULCH	42.12	87.1	A Open, no restriction	N/A	N/A
01101A	ODOT	1979	7	OR 19 (HWY 005) SB	CONDON CANYON CREEK	39.04	98	A Open, no restriction	N/A	N/A
01883A	ODOT	1979	16	OR 206 (HWY 300)	SIX MILE CREEK	49.61	99.8	A Open, no restriction	N/A	N/A
01884A	ODOT	1977	13	OR 206 (HWY 300)	DRY WASH	49.24	99.8	A Open, no restriction	N/A	N/A
03466A	ODOT	1974	17	OR 19 (HWY 005)	CHINA CREEK	4.47	100	A Open, no restriction	N/A	N/A
03467	ODOT	1922	6	OR 19 (HWY 005)	SHUTLER CREEK	7.52	98.6	A Open, no restriction	N/A	N/A
03468	ODOT	1922	6	OR 19 (HWY 005)	W FK SHUTLER CREEK	8.39	96.3	A Open, no restriction	N/A	N/A
03470	ODOT	1949	7	OR 19 (HWY 005)	CATTLEPASS	16.2	99.5	A Open, no restriction	N/A	N/A
03471A	ODOT	1977	14	OR 19 (HWY 005)	CATTLEPASS	23.2	99.2	A Open, no restriction	N/A	N/A
03472	ODOT	1951	7	OR 19 (HWY 005)	CATTLEPASS	35.75	94.6	A Open, no restriction	N/A	N/A
03476A	ODOT	1979	8	OR 19 (HWY 005)	CATTLEPASS & DRAINAGE	40.91	98	A Open, no restriction	N/A	N/A
03477	ODOT	1951	7	OR 19 (HWY 005)	CATTLEPASS	45.03	78.9	A Open, no restriction	N/A	N/A
03484	ODOT	1951	7	OR 74 (HWY 052)	CATTLEPASS	4.55	89	A Open, no restriction	N/A	N/A
03491	ODOT	1954	7	OR 206 (HWY 300)	CATTLEPASS	50.39	99.8	A Open, no restriction	N/A	N/A
08359	ODOT	1957	12	OR 206 (HWY 300)EB	COTTONWOOD CANYON	15.27	94.9	A Open, no restriction	N/A	N/A
08361	ODOT	1957	10	OR 206 (HWY 300)EB	COTTONWOOD CANYON	16.35	96.9	A Open, no restriction	N/A	N/A
09171	ODOT	1964	13	I-84 (HWY 002) WB	WOELPERN INT CONN	131.03	66	A Open, no restriction	N/A	N/A
0P301	ODOT	1964	17	I-84 (HWY 002)	WILDCAT CREEK	123.93	65	A Open, no restriction	N/A	N/A
0P302	ODOT	1964	18	I-84 (HWY 002)	BLALOCK CREEK	129.48	70	A Open, no restriction	N/A	N/A
0P303	ODOT	1964	7	I-84 (HWY 002)	LANG CANYON	133.35	70	A Open, no restriction	N/A	N/A
0P304	ODOT	1964	10	I-84 (HWY 002)	CATTLEPASS	133.43	70	A Open, no restriction	N/A	N/A
0P305	ODOT	1964	9	I-84 (HWY 002)	JONES CANYON	135.86	70	A Open, no restriction	N/A	N/A
0P309	ODOT	1964	14	OR 19 (HWY 005)	PATILL CANYON	46.45	98.3	A Open, no restriction	N/A	N/A
0P310	ODOT	1964	14	OR 19 (HWY 005)	PATILL CANYON	46.79	98.3	A Open, no restriction	N/A	N/A
0P311	ODOT	1964	6	OR 19 (HWY 005)	RAMSEY CANYON	47.76	98.3	A Open, no restriction	N/A	N/A
0P312	ODOT	1964	7	OR 19 (HWY 005)	PATILL CANYON	48.24	98.3	A Open, no restriction	N/A	N/A
0P313	ODOT	1964	7	OR 19 (HWY 005)	DYER CREEK	48.98	98.3	A Open, no restriction	N/A	N/A
0P439	ODOT	1977	14	ON FARM APPROACH	JUNIPER CANYON	23.22	100	A Open, no restriction	N/A	N/A
0P442	ODOT	1979	7	OR 19 (HWY 005) SB	CONDON CANYON CREEK	39.27	98	A Open, no restriction	N/A	N/A
0P443	ODOT	2000	12	OR 19 (HWY 005) SB	CONDON CANYON CREEK	39.48	98	A Open, no restriction	N/A	N/A
0P444	ODOT	1979	14	OR 19 (HWY 005)	CONDON CANYON CREEK	41.48	98	A Open, no restriction	N/A	N/A
0P457	ODOT	1979	7	OR 19 (HWY 005) SB	CODER CREEK	40.26	98	A Open, no restriction	N/A	N/A
13572	ODOT	1972	13	OR 19 (HWY 005) SB	CONDON CANYON CREEK	41.8	95.8	A Open, no restriction	N/A	N/A

MARINE TRANSPORTATION SYSTEM

Gilliam County is located on the Columbia River, a major water transportation route. The Port of Arlington manages river cargo and marina operations. The Port has a Barge Facility available for river access and a grain silo. Farmers in the region use the Port to export grain, which is an important economic activity for the County. From the Columbia River, the grain can travel to Portland and be exported internationally. The marina also provides access to the river for recreational purposes.

PIPELINE TRANSPORTATION SYSTEM

Pipeline transportation within the Gilliam County area includes numerous substations and transmission lines, which are currently being upgraded. These transmission lines are maintained by Pacific Gas Transmission provide access to the main power grid at multiple locations.

FUNDING INVENTORY & ANALYSIS

Roadways within Gilliam County fall under the jurisdiction of the Cities, County, and ODOT. This section discusses the County's existing funding revenue sources for transportation capital improvement projects as well as operations and maintenance activities.

As summarized in Table 19, Gilliam County has had an annual revenue of approximately \$1.3 million per year over the past ten years. This funding covers all transportation related projects, including maintenance and capital improvements projects. Approximately half of the County's transportation revenue each year comes from property taxes. The remaining amounts are obtained from a variety of sources, including ODOT, as shown in Table 19 and vary by year. ODOT has historically been able to fund the County's transportation operations and maintenance activities for state facilities.

Table 20 summarizes the County's transportation expenditures over the past ten years. As shown in the table, the majority of the County's transportation expenditures are used to cover maintenance and snow removal throughout the County.

Table 19. Ten Year Gilliam County Transportation Revenue Budget

Budget Year	Special Assessments-Property Tax	Motor Vehicle Registration Fees	Surplus Land & Equipment Sales	Interest Income	State Highway Fund Apportionment	Special County Allotment	State Highway Fund Exchange Program	ODOT Issued Permit Fees	Other State Highway Fund Grants	BLM Mineral Leases	Other Federal Funds Receipts	Non-Jurisdiction Road work	U.S. Taylor Grazing Apportionment	TOTALS
FY end June 30, 2014	\$ 845,901	\$ -	\$ -	\$ 3,454	\$ 114,014	\$ 289,828	\$ 204,268	\$ -	\$ -	\$ 42,938	\$ -	\$ -	\$ 1,058	\$ 1,501,461
FY end June 30, 2013	\$ 874,995	\$ -	\$ -	\$ 1,615	\$ 116,628	\$ 96,623	\$ 178,751	\$ -	\$ -	\$ 1,634	\$ -	\$ -	\$ 864	\$ 1,271,113
FY end June 30, 2012	\$ 1,119,219	\$ -	\$ -	\$ 4,880	\$ -	\$ 78,539	\$ 186,378	\$ -	\$ -	\$ 7,276	\$ -	\$ -	\$ 968	\$ 1,397,260
FY end June 30, 2011	\$ 931,010	\$ -	\$ -	\$ 6,132	\$ 345,955	\$ 121,963	\$ -	\$ 159,963	\$ -	\$ 7,209	\$ -	\$ -	\$ 3,084	\$ 1,574,875
FY end June 30 2010	\$ 717,073	\$ 131,243	\$ -	\$ 7,666	\$ -	\$ 117,002	\$ -	\$ -	\$ -	\$ 8,688	\$ 237,810	\$ -	\$ 1,048	\$ 1,220,530
FY end June 30, 2009	\$ 432,430	\$ 119,982	\$ 47,132	\$ 13,958	\$ -	\$ 163,001	\$ 186,208	\$ -	\$ 751,404	\$ 4,290	\$ -	\$ -	\$ 967	\$ 1,715,382
FY end June 30, 2008	\$ 450,495	\$ -	\$ -	\$ 20,462	\$ -	\$ 456,183	\$ -	\$ 131,666	\$ -	\$ 248,524	\$ -	\$ 37,493	\$ 931	\$ 1,345,754
FY end June 30, 2007	\$ 404,642	\$ -	\$ -	\$ 16,626	\$ -	\$ 463,554	\$ -	\$ 150,861	\$ -	\$ 62	\$ -	\$ 34,820	\$ 1,256	\$ 1,071,821
FY end June 30, 2006	\$ 385,041	\$ -	\$ -	\$ 4,491	\$ 154,533	\$ 349,134	\$ 266,997	\$ -	\$ -	\$ 31	\$ 24,014	\$ -	\$ 1,284	\$ 1,185,529
FY end June 30 2005	\$ 314,706	\$ -	\$ -	\$ 2,017	\$ 153,376	\$ 468,825	\$ -	\$ -	\$ -	\$ 61	\$ -	\$ -	\$ 1,440	\$ 940,428

Table 20. Ten Year Gilliam County Transportation Expenditures Budget

Budget Year	General Maintenance of Condition	Safety and Traffic Maintenance	Snow and Ice Removal	Administration and General Engineering	Total
FY end June 30, 2014	\$ 1,158,320	\$ 30,178	\$ 56,659	\$ 216,713	\$ 1,461,870
FY end June 30, 2013	\$ 839,223	\$ 49,860	\$ 19,604	\$ 199,496	\$ 1,108,183
FY end June 30, 2012	\$ 1,214,850	\$ 51,116	\$ 23,783	\$ 177,565	\$ 1,467,314
FY end June 30, 2011	\$ 1,633,896	\$ 42,724	\$ 44,646	\$ 185,514	\$ 1,906,780
FY end June 30 2010	\$ 946,253	\$ 34,233	\$ 19,737	\$ 184,001	\$ 1,184,224
FY end June 30, 2009	\$ 577,582	\$ 27,063	\$ 12,002	\$ 172,904	\$ 789,551
FY end June 30, 2008	\$ 704,814	\$ 26,739	\$ 69,276	\$ 172,087	\$ 972,916
FY end June 30, 2007	\$ 650,868	\$ 21,750	\$ 8,041	\$ 159,277	\$ 839,936
FY end June 30, 2006	\$ 359,925	\$ 22,081	\$ 17,816	\$ 134,451	\$ 534,273
FY end June 30 2005	\$ 364,962	\$ 23,623	\$ 13,925	\$ 129,976	\$ 532,486

CONCLUSION

The assessment of the current land use and transportation system conditions identified the following:

- Multiple jurisdictions own and manage the public roadway system within Gilliam County including the Oregon Department of Transportation (ODOT), Gilliam County, and the incorporated cities of Arlington and Condon. Gilliam County, the City of Arlington, and the City of Condon each has their own current TSP, last updated in 1999. This update will combine those into one TSP.
- Gilliam County is connected to the national and statewide highway network via one Interstate Highway (I-84), two Regional Highways, and one District Highway.
- All six study intersections, located on the state highway system, were found to operate with acceptable volume-to-capacity ratios (below their performance targets) during the 30th highest hour condition.
- County two-lane roads are not subject to ODOT standards; however, all County roadways operate with volume-to-capacity ratios less than 0.05 during the peak hour of traffic, indicating the roadways have adequate capacity.
- Although no individual intersections or segment locations were identified with safety issues based on crash history, general County-wide trends indicate that some low-cost systemic treatments such as shoulder widening and installation of centerline and shoulder rumble strips may be effective on County facilities. In addition, treatments that inform drivers of roadway conditions may also be effective at reducing weather related crashes. These options should be further evaluated.
- Several intersections were identified based on design concerns and field observations related to sight distance and/or capacity:
 - Walnut Street/Main Street in Condon;
 - Lone Rock Road/OR 206;
 - I-84 Ramps/Arlington Port Road in Arlington.
- The downtown Main Street corridor in Condon contains continuous sidewalks. However, the remainder of Condon and Arlington lack continuous sidewalks providing pedestrians with access to destinations in the cities.
- Bicycles typically ride in the travel lane throughout the County due to the lack of wide shoulders on the state highways. OR 206 and OR 19, south of Condon, are popular recreational bicycling routes. Although traffic volumes are low, conflicts between vehicles and bicyclists may arise when large groups of cyclists are traveling these routes.
- There is no fixed route transit service in the County. The County operates a dial-a-ride service, available to all residents, with volunteer drivers. These services are primarily used for medical purposes and often involve long trips to take residents to hospitals in The Dalles or Portland.
- Arlington and Condon both have general aviation airports.

- The County's largest industries are agriculture, waste management, and wind energy. There are several large industrial lands located in the County and in Arlington that are available for future development.
- Freight traffic travel occurs by truck, rail, and boat. A rail line spur connects the Columbia Ridge Landfill with the railroad that travels east-west along the Columbia River. The Port of Arlington provides access to the Columbia River for freight movement. OR 19 provides connections to I-84 for the trucking industry.
- Historically, the County and ODOT have funded the general maintenance and upkeep of the Gilliam County roadways. No additional funds are available for large capital projects.

These conclusions will be used to inform the alternatives considered for the TSP.

REFERENCES

1. Oregon Highway Plan
2. 2010 Highway Capacity Manual
3. ODOT Analysis Procedures Manual

APPENDICES

DRAFT

Appendix 1 Buildable Lands Inventory for
Cities

CITY OF LONE ROCK GILLIAM COUNTY, OREGON SEPTEMBER, 2014

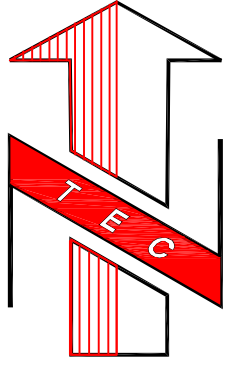

0' 20' 40' 60' 120'
SCALE IN FEET

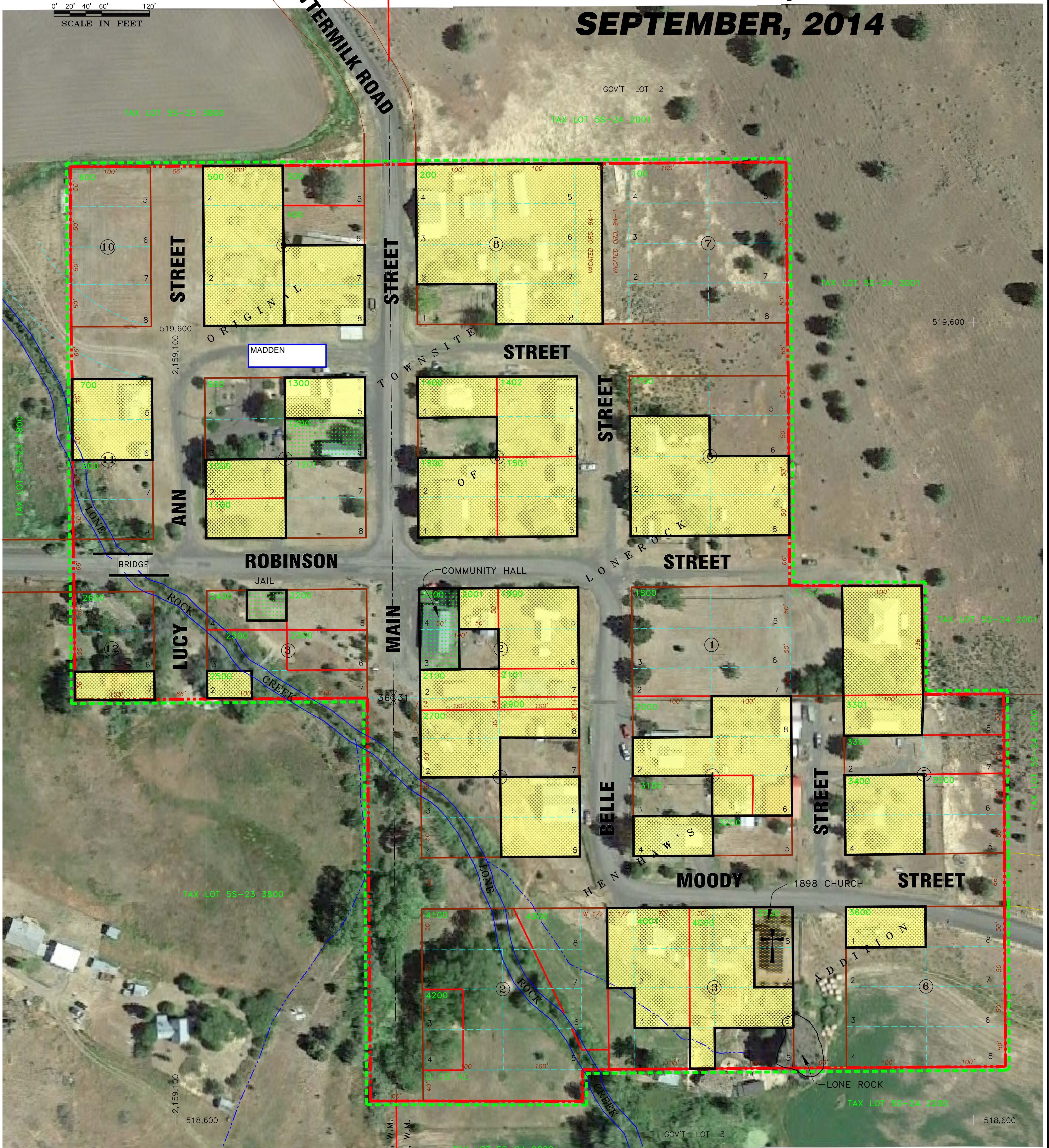

LEGEND:
- - - - - CITY LIMITS LINE (23.1 AC.)
- - - - - URBAN GROWTH BOUNDARY

- LEGEND:**
- BUILDABLE LAND (UNDEVELOPED)
 - DEVELOPED (RESIDENTIAL) PROPERTY
 - DEVELOPED PROPERTY COMMERCIAL/INDUSTRIAL)
 - DEVELOPED (PUBLIC) PROPERTY
 - + DEVELOPED (CHURCH) PROPERTY

BUILDABLE LANDS MAP

CITY OF CONDON

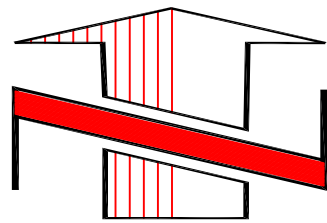

GILLIAM COUNTY, OREGON
IN SECTIONS 2, 3, 4, 9, 10, 11 AND 15,
TWP. 4 S., RANGE 21 E., W.M.
SEPTEMBER, 2014

BUILDABLE LANDS INVENTORY



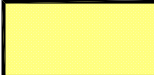
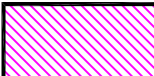

0' 700' 1400'
SCALE IN FEET

LEGEND:

-  BUILDABLE LAND (UNDEVELOPED)
-  DEVELOPED (RESIDENTIAL) PROPERTY
-  DEVELOPED PROPERTY COMMERCIAL/INDUSTRIAL
-  DEVELOPED (PUBLIC) PROPERTY
-  DEVELOPED (CHURCH) PROPERTY

 **F** FLOOD ZONE

-  CONDON CITY LIMITS LINE (512 AC.±)
-  URBAN GROWTH BOUNDARY (823 AC.±)

TENNESON ENGINEERING CORP.
CONSULTING ENGINEERS
3775 CRATES WAY
THE DALLES, OREGON 97058
541-296-9177 FAX 541-296-6657

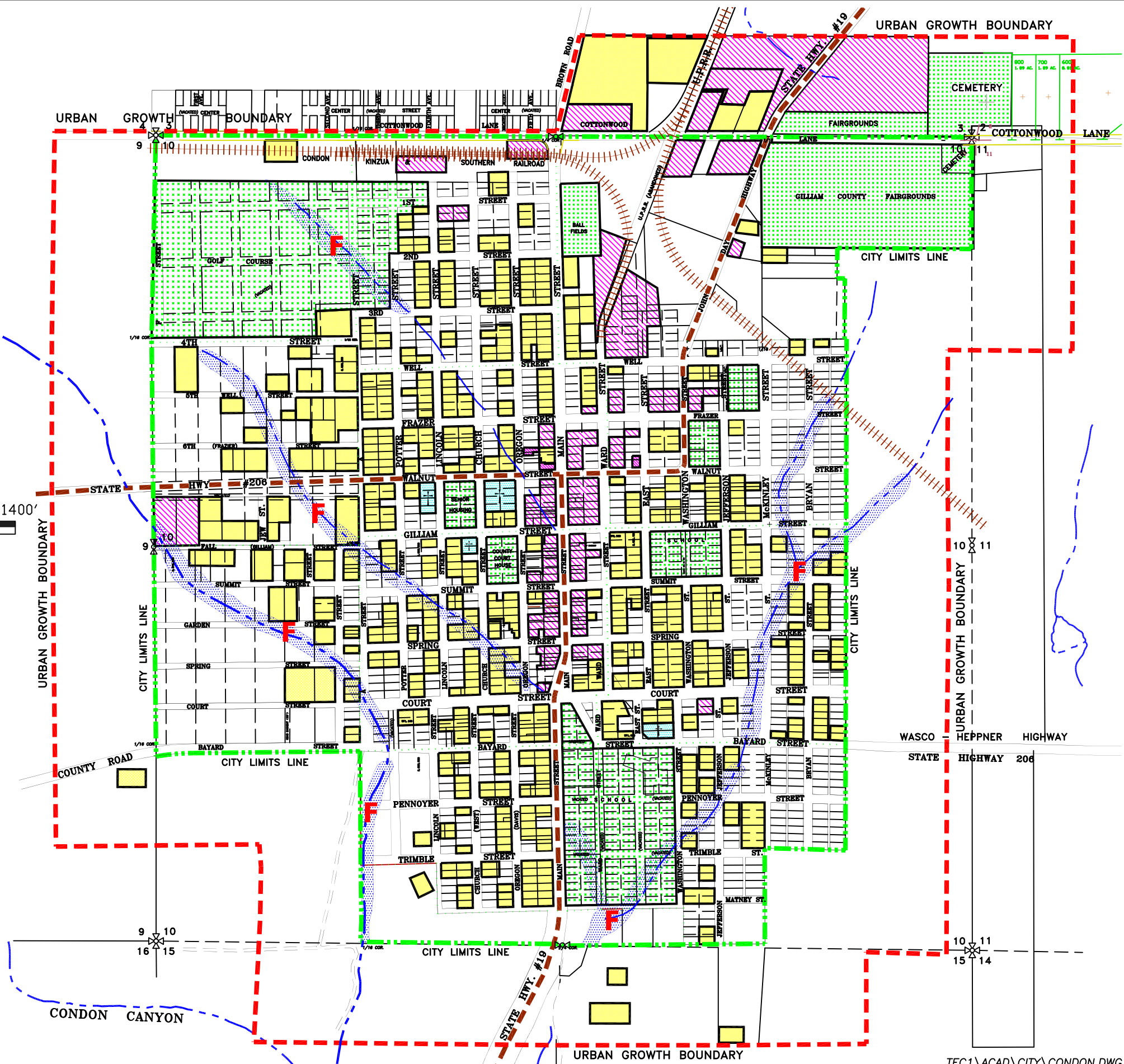

CITY OF ARLINGTON GILLIAM COUNTY, OREGON SEPTEMBER, 2014

LEGEND:
 - - - - - CITY LIMITS LINE (1,775 AC.)
 - - - - - URBAN GROWTH BOUNDARY (2,200 AC.)

BUILDABLE LANDS MAP

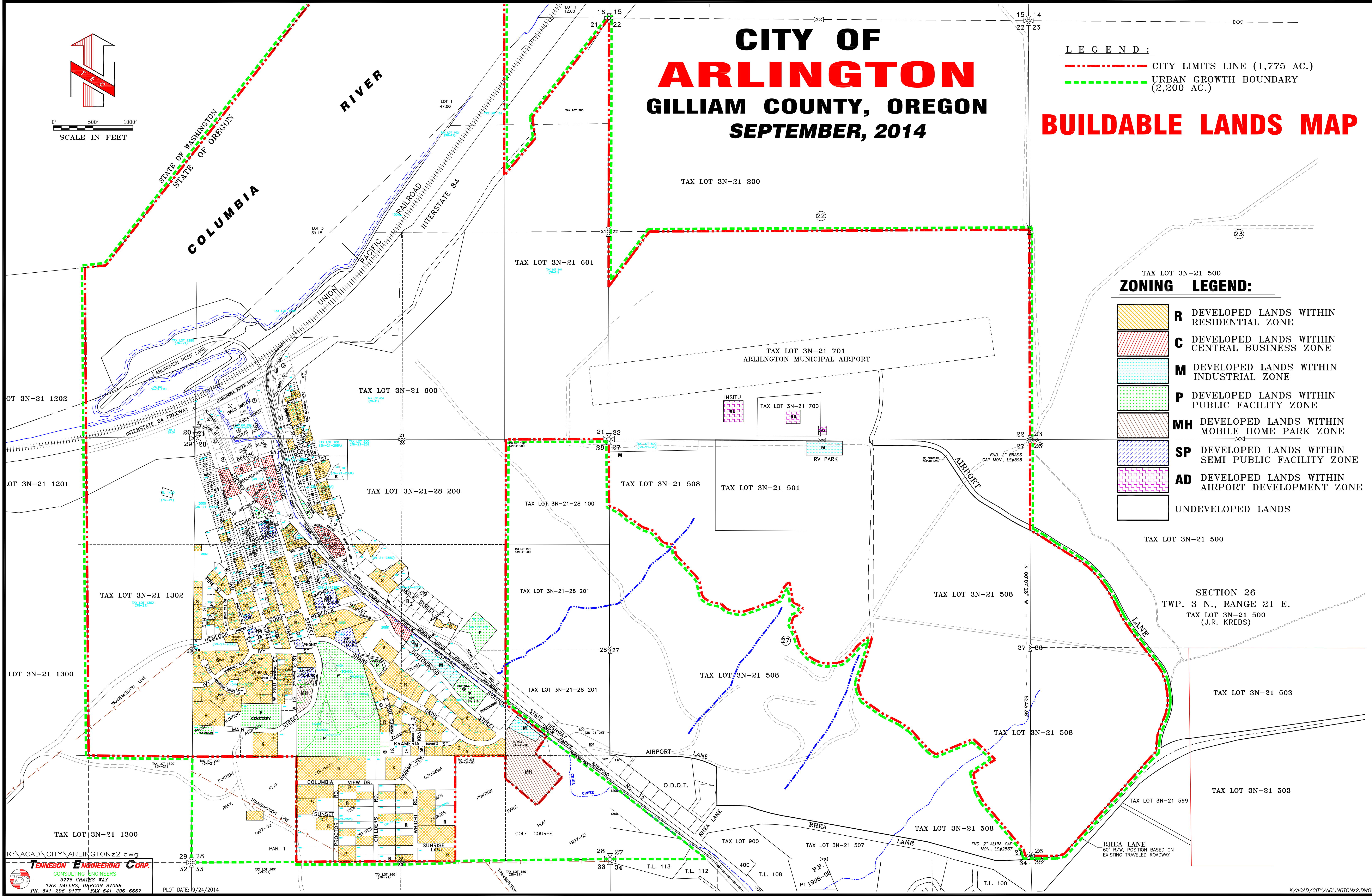
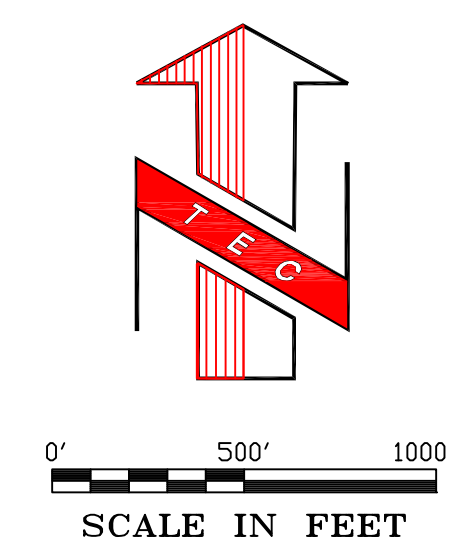

ZONING LEGEND:

	R DEVELOPED LANDS WITHIN RESIDENTIAL ZONE
	C DEVELOPED LANDS WITHIN CENTRAL BUSINESS ZONE
	M DEVELOPED LANDS WITHIN INDUSTRIAL ZONE
	P DEVELOPED LANDS WITHIN PUBLIC FACILITY ZONE
	MH DEVELOPED LANDS WITHIN MOBILE HOME PARK ZONE
	SP DEVELOPED LANDS WITHIN SEMI PUBLIC FACILITY ZONE
	AD DEVELOPED LANDS WITHIN AIRPORT DEVELOPMENT ZONE
	UNDEVELOPED LANDS

K:\ACAD\CITY\ARLINGTONz2.dwg
TENNESON ENGINEERING CORP.
 CONSULTING ENGINEERS
 3776 CRAVES WAY
 THE DALLES, OREGON 97058
 PH. 541-298-9177 FAX 541-298-6657

PLOT DATE: 9/24/2014

K:\ACAD\CITY\ARLINGTONz2.DWG
 W.O. #11700

DRAFT

Appendix 2 Traffic Count Data

Time Series- Lonerock Road

Period: 7/29/2014-7/31/2014 | Grouping: By 15min | Lane / Direction / Flow: Whole Section | Vehicle Type: Vehicles | Axle Group: ALL | Weight Bin: ALL | Q | Data Basis: 110001 [15min] |

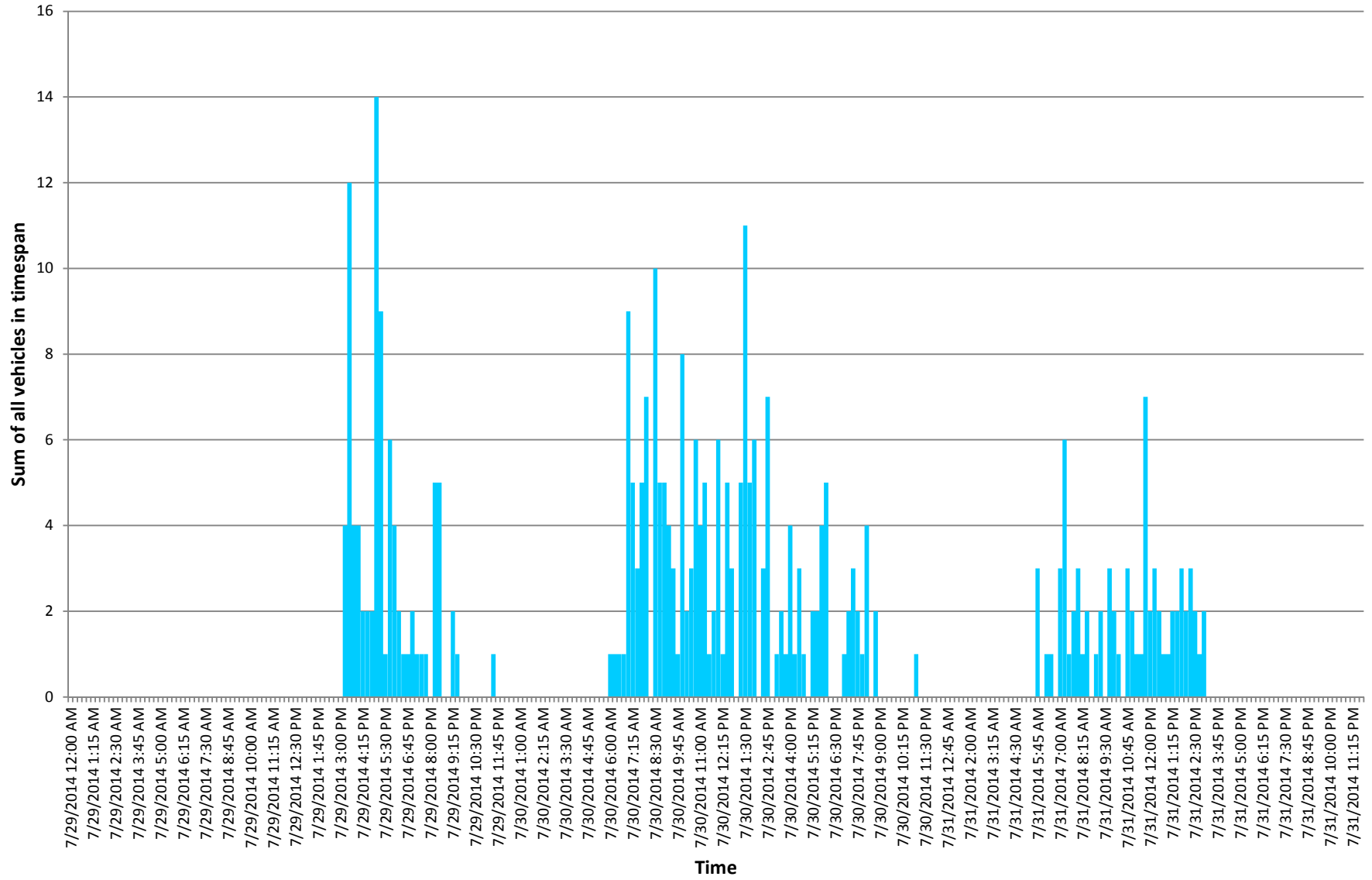

Time Series - Baseline Road

Period: 7/29/2014-7/31/2014 | Grouping: By 15min | Lane / Direction / Flow: Whole Section | Vehicle Type: Vehicles | Axle Group: ALL | Weight Bin: ALL | Q | Data Basis: 110006 [15min] |

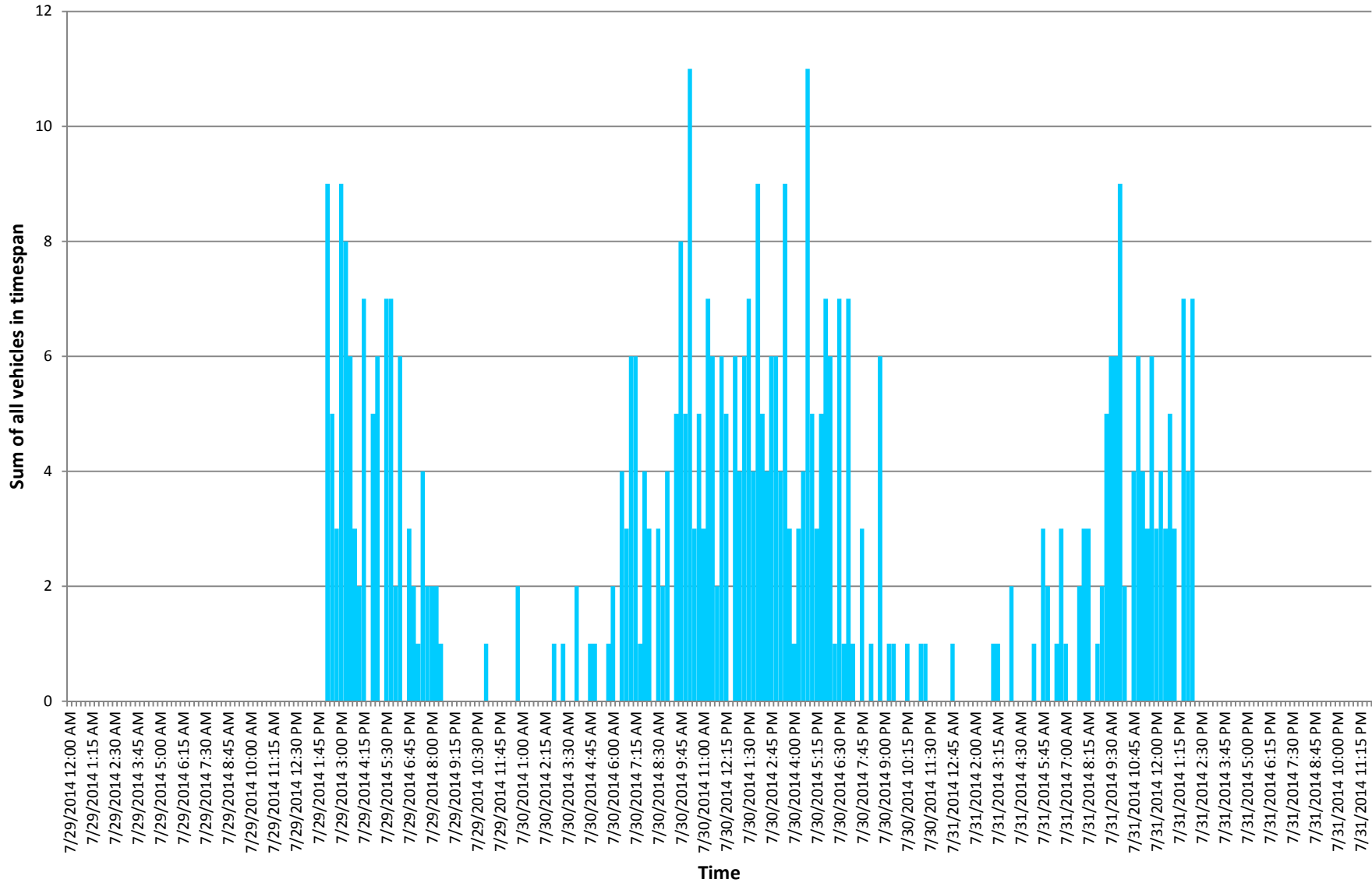

Time Series- Fourmile Road

Period: 7/29/2014-7/31/2014 | Grouping: By 15min | Lane / Direction / Flow: Whole Section | Vehicle Type: Vehicles | Axle Group: ALL | Weight Bin: ALL | Q | Data Basis: 110007 [15min] |

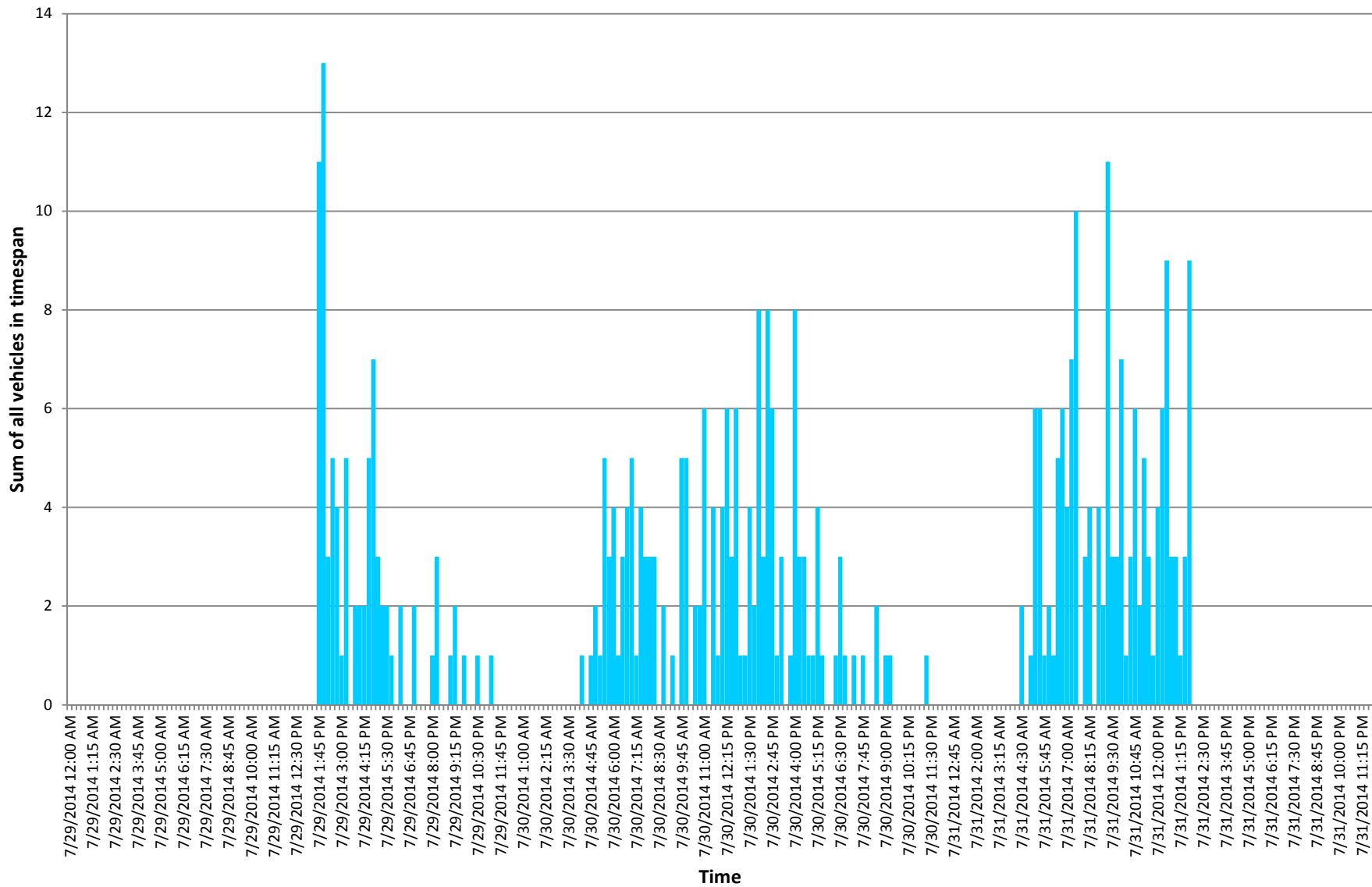

Time Series- Blalock Canyon Road

Period: 7/29/2014-7/31/2014 | Grouping: By 15min | Lane / Direction / Flow: Whole Section | Vehicle Type: Vehicles | Axle Group: ALL | Weight Bin: ALL | Q | Data Basis: 16277 [15min] |

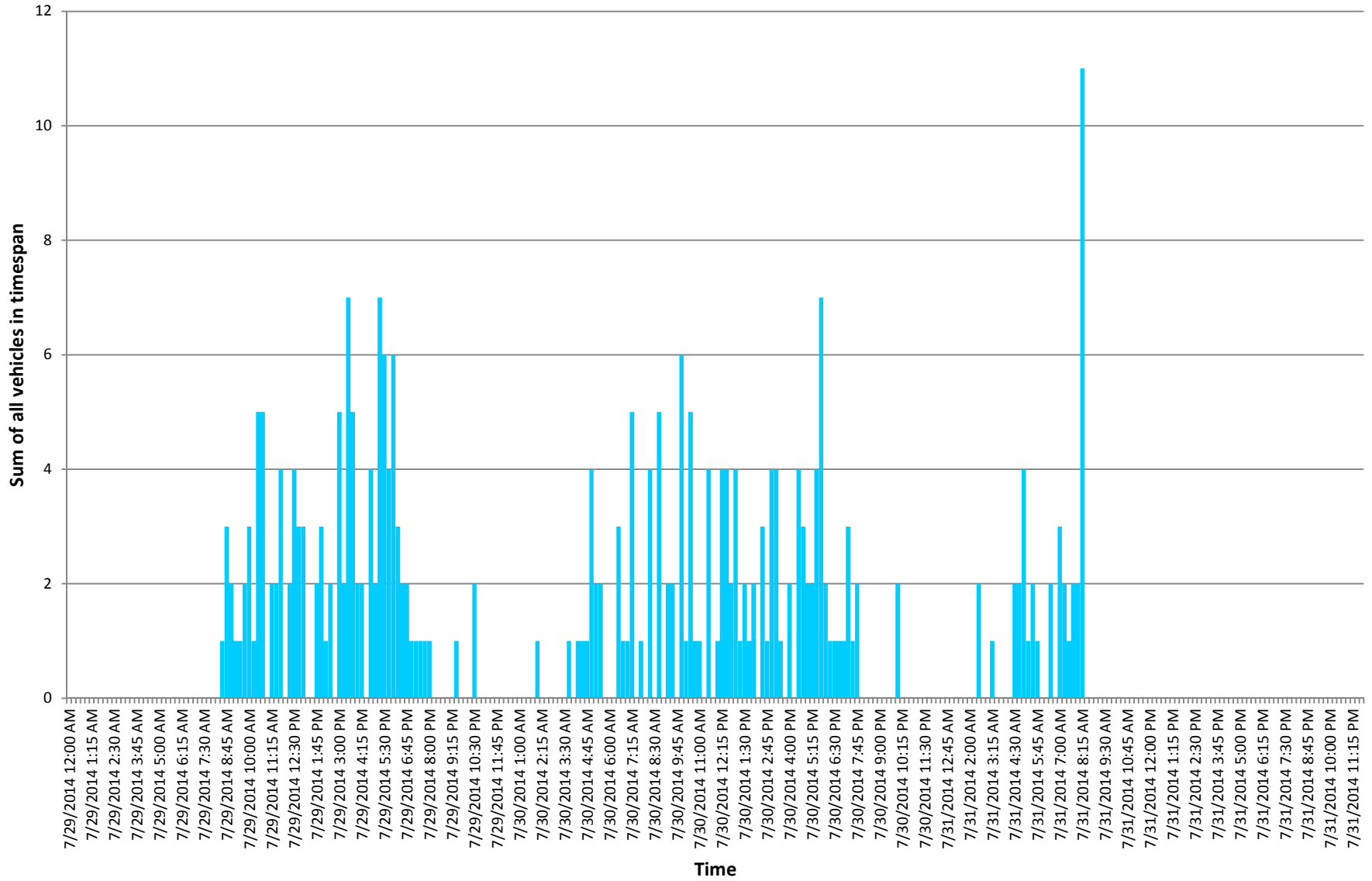

Time Series - Quinton Canyon Road

Period: 7/29/2014-7/31/2014 | Grouping: By 15min | Lane / Direction / Flow: Whole Section | Vehicle Type: Vehicles | Axle Group: ALL | Weight Bin: ALL | Q | Data Basis: 16272 [15min] |

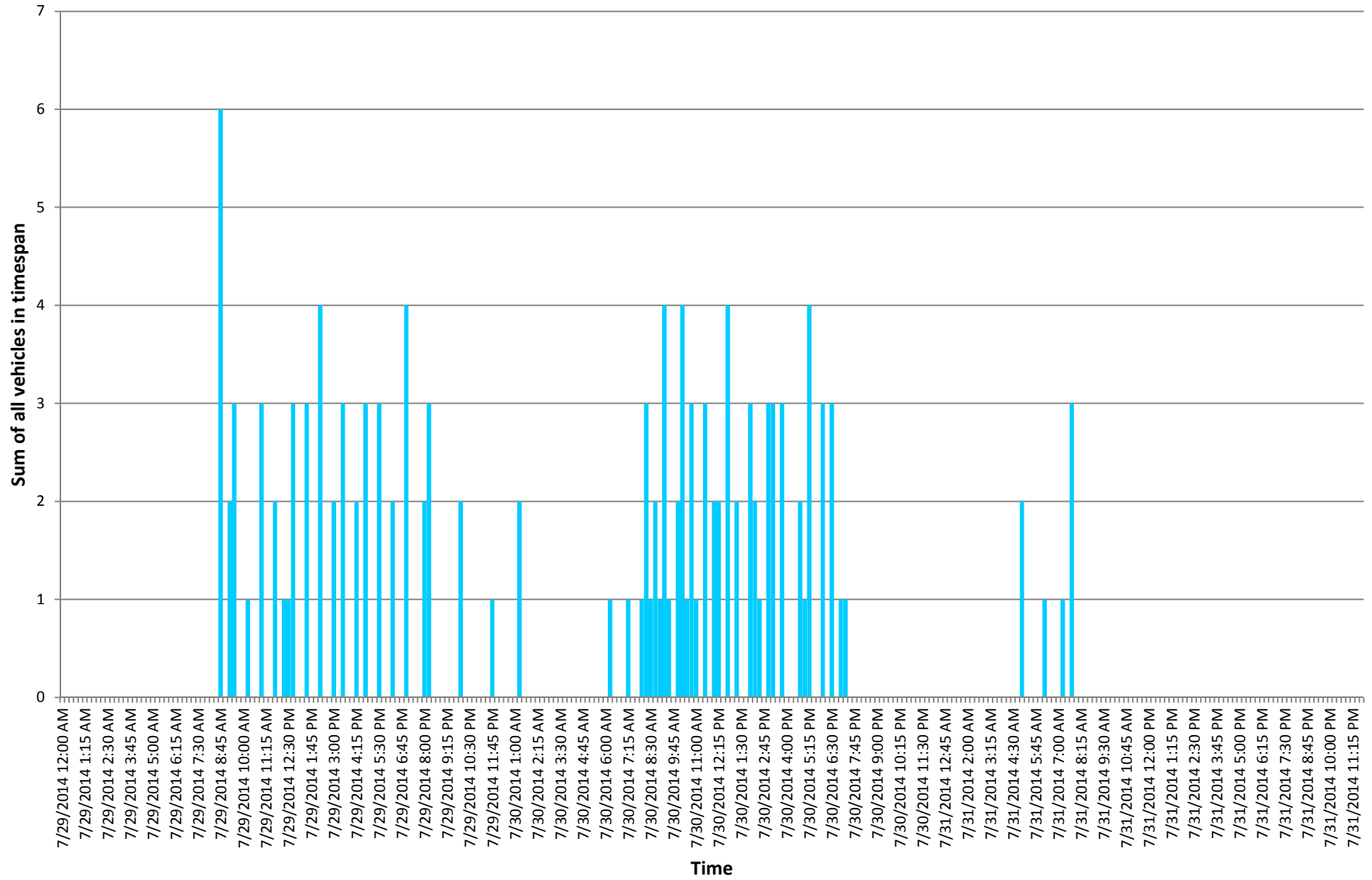

Time Series - Mikkalo Lane

Period: 7/29/2014-7/31/2014 | Grouping: By 15min | Lane / Direction / Flow: Whole Section | Vehicle Type: Vehicles | Axle Group: ALL | Weight Bin: ALL | Q | Data Basis: 110003 [15min] |

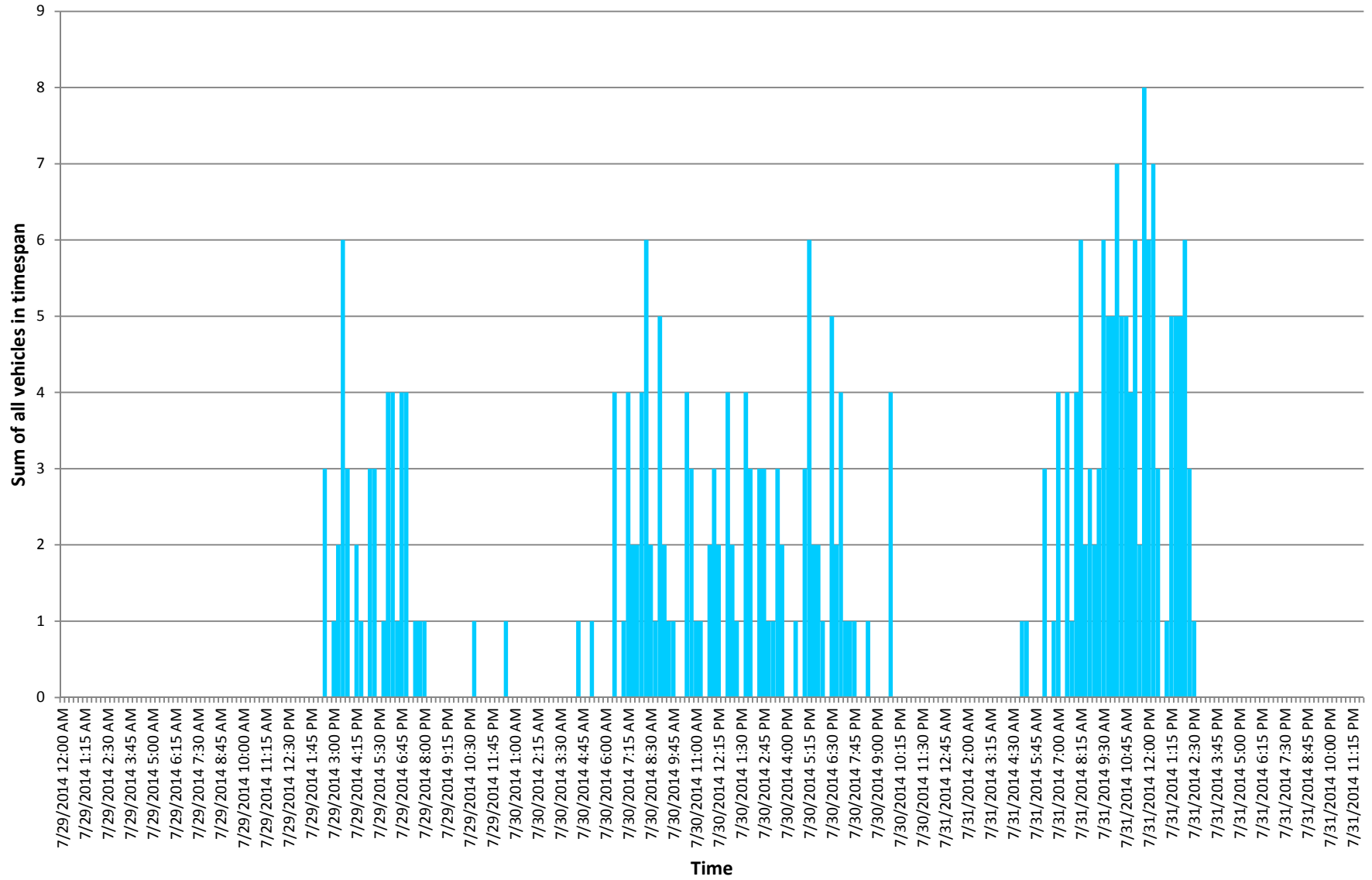

Time Series- E Bayard Street

Period: 7/29/2014-7/31/2014 | Grouping: By 15min | Lane / Direction / Flow: Whole Section | Vehicle Type: Vehicles | Axle Group: ALL | Weight Bin: ALL | Q | Data Basis: 4213 [15min] |

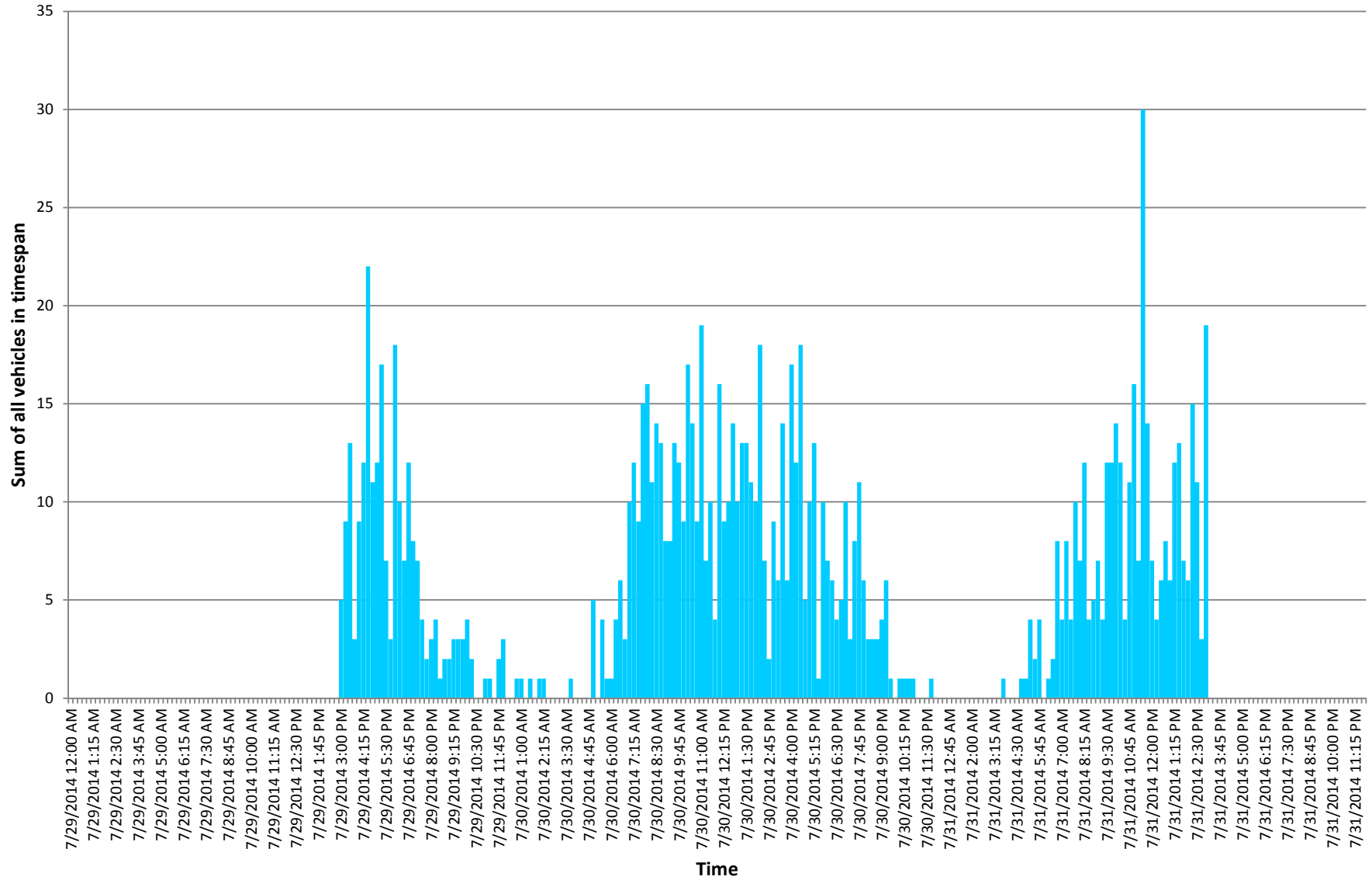

File Name : #1 MAIN&WALNUT
Site Code :
Start Date : 11/19/2014
Page No : 1

Groups Printed- Lights - HV

Start Time	S MAIN ST Southbound				W WALNUT ST - WASCO HEPNER Westbound				S MAIN ST Northbound				W WALNUT ST - WASCO HEPNER Eastbound				Int. Total
	Right	Thru	Left	Peds	Right	Thru	Left	Peds	Right	Thru	Left	Peds	Right	Thru	Left	Peds	
05:00 AM	0	1	1	0	0	0	0	0	3	0	0	0	1	2	1	0	9
05:15 AM	0	0	0	0	0	0	0	0	0	0	0	0	1	1	0	0	2
05:30 AM	0	0	0	0	0	0	2	0	1	0	0	0	0	0	0	0	3
05:45 AM	0	0	0	0	0	1	0	0	1	0	0	0	0	1	0	0	3
Total	0	1	1	0	0	1	2	0	5	0	0	0	2	4	1	0	17
06:00 AM	1	3	0	0	0	2	2	0	2	1	0	0	0	0	0	0	11
06:15 AM	0	1	0	0	0	3	0	0	4	2	0	0	0	2	1	0	13
06:30 AM	0	1	0	0	2	2	2	0	4	0	4	0	2	4	1	0	22
06:45 AM	0	4	0	0	0	8	1	0	1	0	4	0	1	4	1	0	24
Total	1	9	0	0	2	15	5	0	11	3	8	0	3	10	3	0	70
07:00 AM	0	5	0	0	0	3	1	0	4	1	2	0	0	3	0	0	19
07:15 AM	0	0	1	0	0	1	2	0	1	0	0	0	3	1	0	0	9
07:30 AM	1	1	2	0	0	1	1	0	0	1	5	0	2	5	0	0	19
07:45 AM	0	5	1	0	2	3	8	0	6	3	6	0	10	1	0	0	45
Total	1	11	4	0	2	8	12	0	11	5	13	0	15	10	0	0	92
08:00 AM	1	2	1	0	3	5	3	0	2	2	4	0	3	1	0	0	27
08:15 AM	1	2	2	0	1	1	6	0	5	3	4	0	1	4	0	0	30
08:30 AM	0	4	1	0	1	0	4	0	2	3	2	0	3	3	1	0	24
08:45 AM	0	2	0	0	0	1	3	0	4	4	3	0	3	1	0	0	21
Total	2	10	4	0	5	7	16	0	13	12	13	0	10	9	1	0	102
09:00 AM	2	2	0	0	0	2	5	0	5	2	2	0	2	1	1	0	24
09:15 AM	0	1	1	0	1	0	4	0	3	4	2	0	4	2	2	1	25
09:30 AM	0	3	0	0	1	1	3	0	7	5	3	0	2	3	0	0	28
09:45 AM	0	5	0	0	1	2	2	0	2	3	1	2	6	5	0	0	29
Total	2	11	1	0	3	5	14	0	17	14	8	2	14	11	3	1	106
10:00 AM	2	1	0	0	0	2	6	0	4	4	1	1	3	1	1	0	26
10:15 AM	1	3	0	0	2	2	6	0	4	2	3	0	3	0	1	0	27
10:30 AM	0	4	1	0	0	0	2	0	3	5	5	0	3	0	2	2	27
10:45 AM	0	5	0	0	0	4	3	0	3	4	3	0	5	1	1	2	31
Total	3	13	1	0	2	8	17	0	14	15	12	1	14	2	5	4	111
11:00 AM	0	0	2	0	0	1	7	0	5	3	3	0	1	1	1	0	24
11:15 AM	2	2	0	0	0	2	2	0	3	2	3	1	8	2	1	0	28
11:30 AM	0	4	0	0	0	3	3	0	6	3	3	0	2	1	0	0	25
11:45 AM	2	2	1	0	0	2	3	0	5	2	3	0	7	2	0	1	30
Total	4	8	3	0	0	8	15	0	19	10	12	1	18	6	2	1	107
12:00 PM	2	6	1	0	0	4	6	0	5	2	6	0	4	3	1	0	40
12:15 PM	0	5	0	0	0	4	3	0	4	4	8	0	7	1	0	0	36
12:30 PM	0	2	0	0	1	2	2	0	5	4	4	0	6	3	1	0	30
12:45 PM	1	1	0	0	0	7	8	0	8	4	6	0	5	2	0	1	43
Total	3	14	1	0	1	17	19	0	22	14	24	0	22	9	2	1	149
01:00 PM	0	2	0	0	1	4	2	0	5	5	5	0	2	2	0	0	28
01:15 PM	0	4	3	0	0	1	5	0	3	3	3	0	5	1	0	0	28
01:30 PM	0	4	0	0	4	5	5	0	6	3	3	0	2	4	0	0	36
01:45 PM	2	4	0	0	1	1	6	0	3	3	4	0	4	2	0	0	30
Total	2	14	3	0	6	11	18	0	17	14	15	0	13	9	0	0	122

File Name : #1 MAIN&WALNUT
Site Code :
Start Date : 11/19/2014
Page No : 2

Groups Printed- Lights - HV

Start Time	S MAIN ST Southbound				W WALNUT ST - WASCO HEPNER Westbound				S MAIN ST Northbound				W WALNUT ST - WASCO HEPNER Eastbound				Int. Total
	Right	Thru	Left	Peds	Right	Thru	Left	Peds	Right	Thru	Left	Peds	Right	Thru	Left	Peds	
02:00 PM	1	2	1	0	1	2	3	0	2	1	4	0	6	3	1	0	27
02:15 PM	0	1	0	0	1	5	5	0	5	5	4	0	5	3	1	0	35
02:30 PM	0	3	0	0	0	2	5	0	2	0	3	0	7	4	2	0	28
02:45 PM	0	3	0	0	1	2	4	0	7	1	2	0	7	1	2	0	30
Total	1	9	1	0	3	11	17	0	16	7	13	0	25	11	6	0	120
03:00 PM	0	4	0	0	2	4	6	0	5	3	5	0	4	3	0	0	36
03:15 PM	1	2	1	0	0	2	1	0	7	5	2	0	3	1	1	0	26
03:30 PM	1	10	2	0	1	3	11	0	5	8	3	0	5	6	1	0	56
03:45 PM	1	5	0	0	3	0	5	0	7	7	9	0	4	2	2	0	45
Total	3	21	3	0	6	9	23	0	24	23	19	0	16	12	4	0	163
04:00 PM	1	7	1	0	0	2	5	0	5	8	1	0	6	3	1	0	40
04:15 PM	1	3	1	0	5	6	2	0	5	6	4	0	4	8	1	0	46
04:30 PM	2	6	2	0	2	4	9	0	5	8	5	0	9	9	0	0	61
04:45 PM	0	7	5	0	1	7	4	0	4	5	4	0	0	5	0	0	42
Total	4	23	9	0	8	19	20	0	19	27	14	0	19	25	2	0	189
05:00 PM	1	6	1	0	0	2	5	0	3	3	4	0	4	2	3	0	34
05:15 PM	1	1	3	0	1	5	7	0	8	3	2	0	0	6	3	0	40
05:30 PM	0	3	2	0	1	4	3	0	3	4	5	1	2	5	0	0	33
05:45 PM	1	0	0	0	0	4	1	0	1	0	3	0	1	3	0	0	14
Total	3	10	6	0	2	15	16	0	15	10	14	1	7	16	6	0	121
06:00 PM	0	1	0	0	0	4	4	0	1	1	1	0	3	3	1	0	19
06:15 PM	1	0	0	0	0	3	2	0	6	1	3	0	7	0	0	0	23
06:30 PM	0	2	0	0	0	1	3	0	2	2	4	0	2	0	0	0	16
06:45 PM	0	1	0	0	0	1	0	0	0	1	2	0	1	0	0	0	6
Total	1	4	0	0	0	9	9	0	9	5	10	0	13	3	1	0	64
07:00 PM	1	3	0	0	2	1	1	0	0	3	3	0	0	0	1	0	15
07:15 PM	0	2	0	0	1	1	0	0	0	0	0	0	1	1	0	0	6
07:30 PM	0	1	1	0	0	1	0	0	0	0	2	0	1	2	0	0	8
07:45 PM	0	0	0	0	0	0	0	0	0	1	2	0	1	1	0	0	5
Total	1	6	1	0	3	3	1	0	0	4	7	0	3	4	1	0	34
08:00 PM	0	1	0	0	0	0	0	0	1	1	1	0	2	1	0	0	7
08:15 PM	0	3	0	0	1	0	1	0	2	3	1	0	0	2	0	0	13
08:30 PM	0	0	1	0	0	0	3	0	2	1	2	0	0	1	1	0	11
08:45 PM	0	0	0	0	1	1	1	0	0	0	0	0	0	0	0	0	3
Total	0	4	1	0	2	1	5	0	5	5	4	0	2	4	1	0	34
Grand Total	31	168	39	0	45	147	209	0	217	168	186	5	196	145	38	7	1601
Apprch %	13	70.6	16.4	0	11.2	36.7	52.1	0	37.7	29.2	32.3	0.9	50.8	37.6	9.8	1.8	
Total %	1.9	10.5	2.4	0	2.8	9.2	13.1	0	13.6	10.5	11.6	0.3	12.2	9.1	2.4	0.4	
Lights	25	162	38	0	43	145	189	0	205	165	178	5	193	133	28	7	1516
% Lights	80.6	96.4	97.4	0	95.6	98.6	90.4	0	94.5	98.2	95.7	100	98.5	91.7	73.7	100	94.7
HV	6	6	1	0	2	2	20	0	12	3	8	0	3	12	10	0	85
% HV	19.4	3.6	2.6	0	4.4	1.4	9.6	0	5.5	1.8	4.3	0	1.5	8.3	26.3	0	5.3

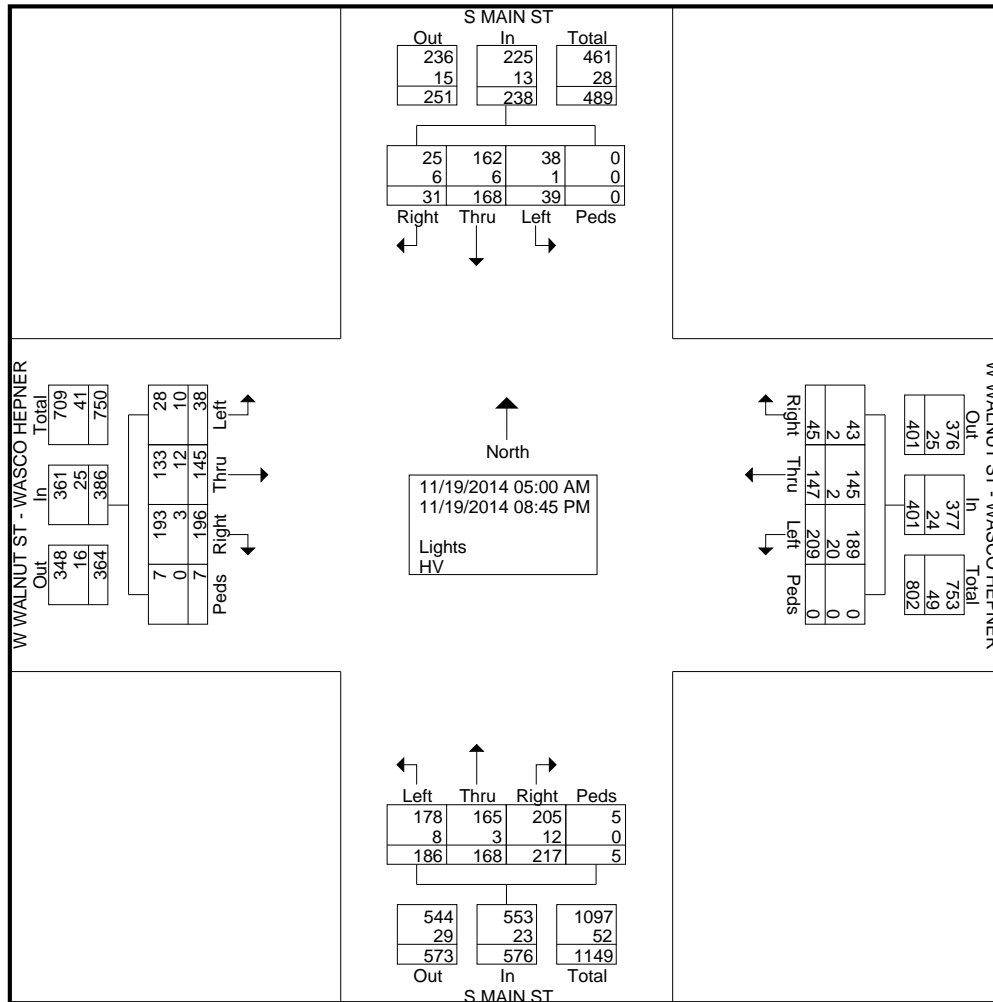

Start Time	S MAIN ST Southbound					W WALNUT ST - WASCO HEPNER Westbound					S MAIN ST Northbound					W WALNUT ST - WASCO HEPNER Eastbound					Int. Total
	Right	Thru	Left	Peds	App. Total	Right	Thru	Left	Peds	App. Total	Right	Thru	Left	Peds	App. Total	Right	Thru	Left	Peds	App. Total	
Peak Hour Analysis From 05:00 AM to 09:45 AM - Peak 1 of 1																					
Peak Hour for Entire Intersection Begins at 07:45 AM																					
07:45 AM	0	5	1	0	6	2	3	8	0	13	6	3	6	0	15	10	1	0	0	11	45
08:00 AM	1	2	1	0	4	3	5	3	0	11	2	2	4	0	8	3	1	0	0	4	27
08:15 AM	1	2	2	0	5	1	1	6	0	8	5	3	4	0	12	1	4	0	0	5	30
08:30 AM	0	4	1	0	5	1	0	4	0	5	2	3	2	0	7	3	3	1	0	7	24
Total Volume	2	13	5	0	20	7	9	21	0	37	15	11	16	0	42	17	9	1	0	27	126
% App. Total	10	65	25	0		18.9	24.3	56.8	0		35.7	26.2	38.1	0		63	33.3	3.7	0		
PHF	.500	.650	.625	.000	.833	.583	.450	.656	.000	.712	.625	.917	.667	.000	.700	.425	.563	.250	.000	.614	.700

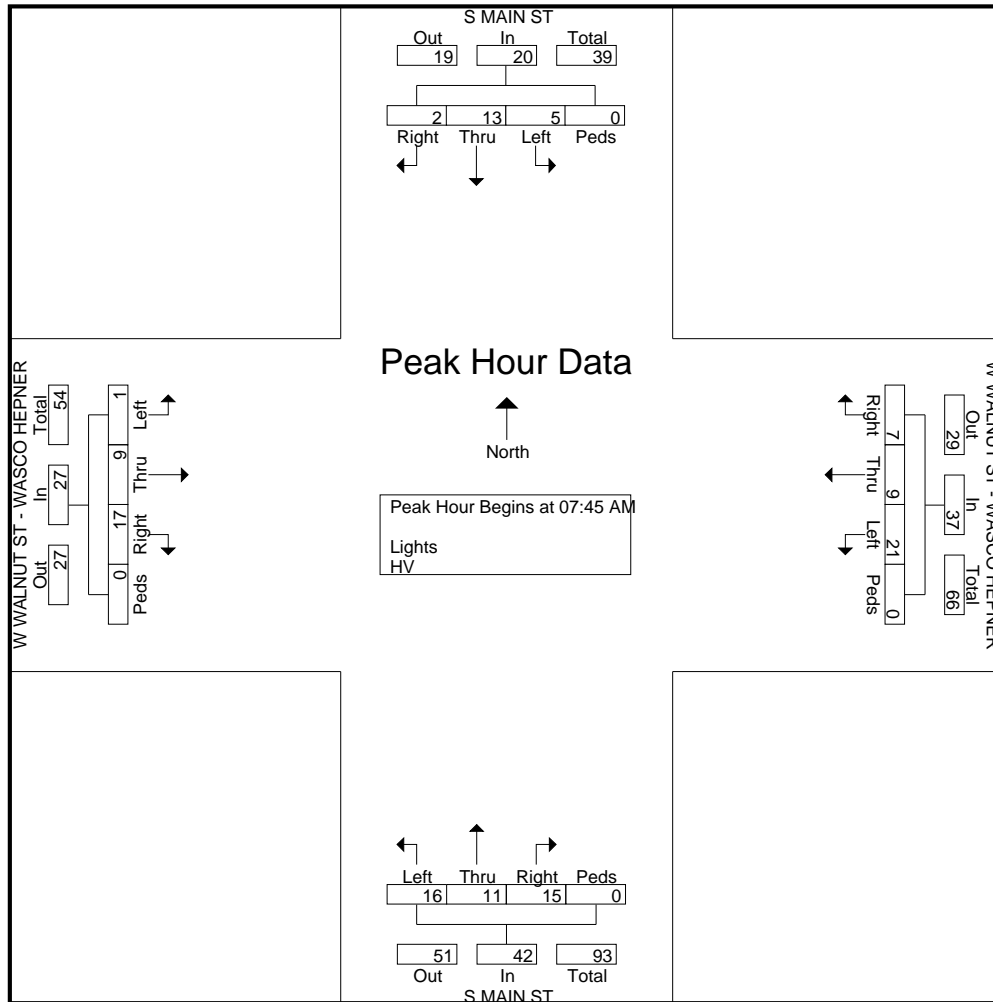

Peak Hour Analysis From 10:00 AM to 01:45 PM - Peak 1 of 1

Peak Hour for Entire Intersection Begins at 12:00 PM

12:00 PM	2	6	1	0	9	0	4	6	0	10	5	2	6	0	13	4	3	1	0	8	40
12:15 PM	0	5	0	0	5	0	4	3	0	7	4	4	8	0	16	7	1	0	0	8	36
12:30 PM	0	2	0	0	2	1	2	2	0	5	5	4	4	0	13	6	3	1	0	10	30
12:45 PM	1	1	0	0	2	0	7	8	0	15	8	4	6	0	18	5	2	0	1	8	43
Total Volume	3	14	1	0	18	1	17	19	0	37	22	14	24	0	60	22	9	2	1	34	149
% App. Total	16.7	77.8	5.6	0		2.7	45.9	51.4	0		36.7	23.3	40	0		64.7	26.5	5.9	2.9		
PHF	.375	.583	.250	.000	.500	.250	.607	.594	.000	.617	.688	.875	.750	.000	.833	.786	.750	.500	.250	.850	.866

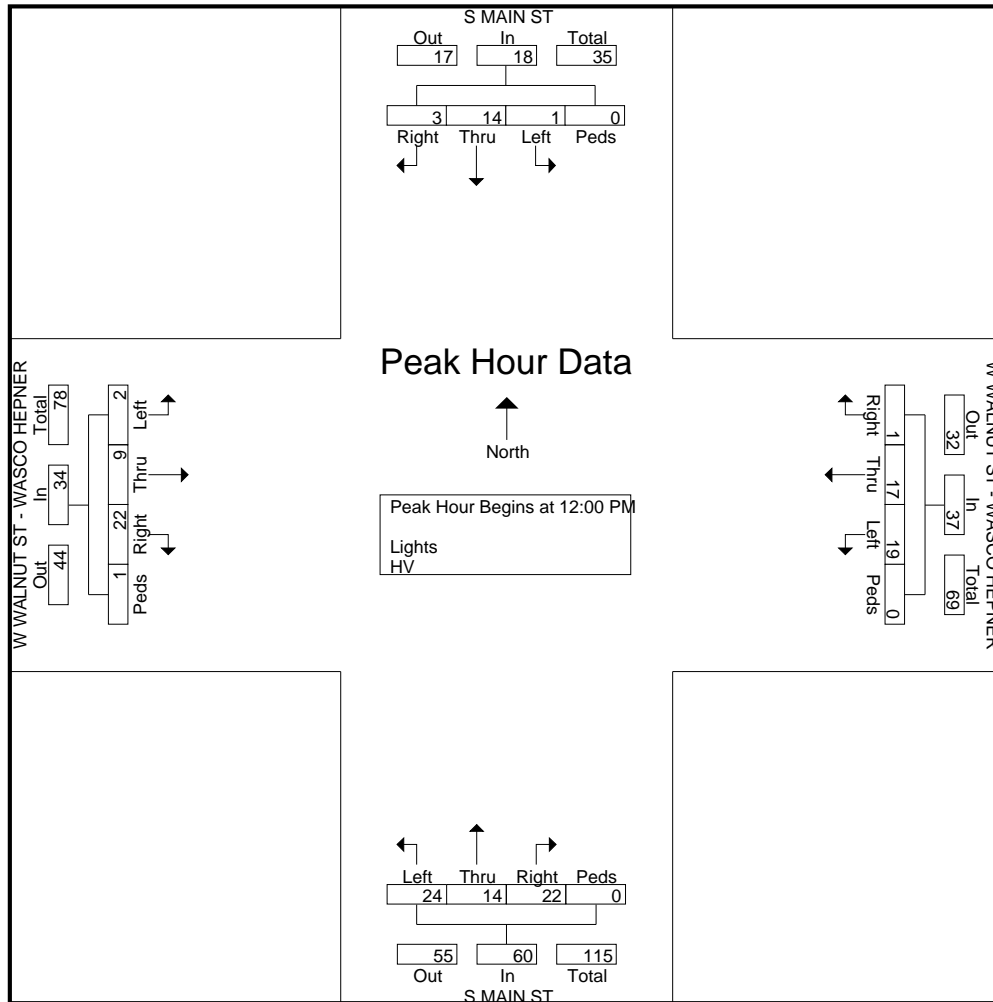

Peak Hour Analysis From 02:00 PM to 08:45 PM - Peak 1 of 1
Peak Hour for Entire Intersection Begins at 03:45 PM

03:45 PM	1	5	0	0	6	3	0	5	0	8	7	7	9	0	23	4	2	2	0	8	45
04:00 PM	1	7	1	0	9	0	2	5	0	7	5	8	1	0	14	6	3	1	0	10	40
04:15 PM	1	3	1	0	5	5	6	2	0	13	5	6	4	0	15	4	8	1	0	13	46
04:30 PM	2	6	2	0	10	2	4	9	0	15	5	8	5	0	18	9	9	0	0	18	61
Total Volume	5	21	4	0	30	10	12	21	0	43	22	29	19	0	70	23	22	4	0	49	192
% App. Total	16.7	70	13.3	0		23.3	27.9	48.8	0		31.4	41.4	27.1	0		46.9	44.9	8.2	0		
PHF	.625	.750	.500	.000	.750	.500	.500	.583	.000	.717	.786	.906	.528	.000	.761	.639	.611	.500	.000	.681	.787

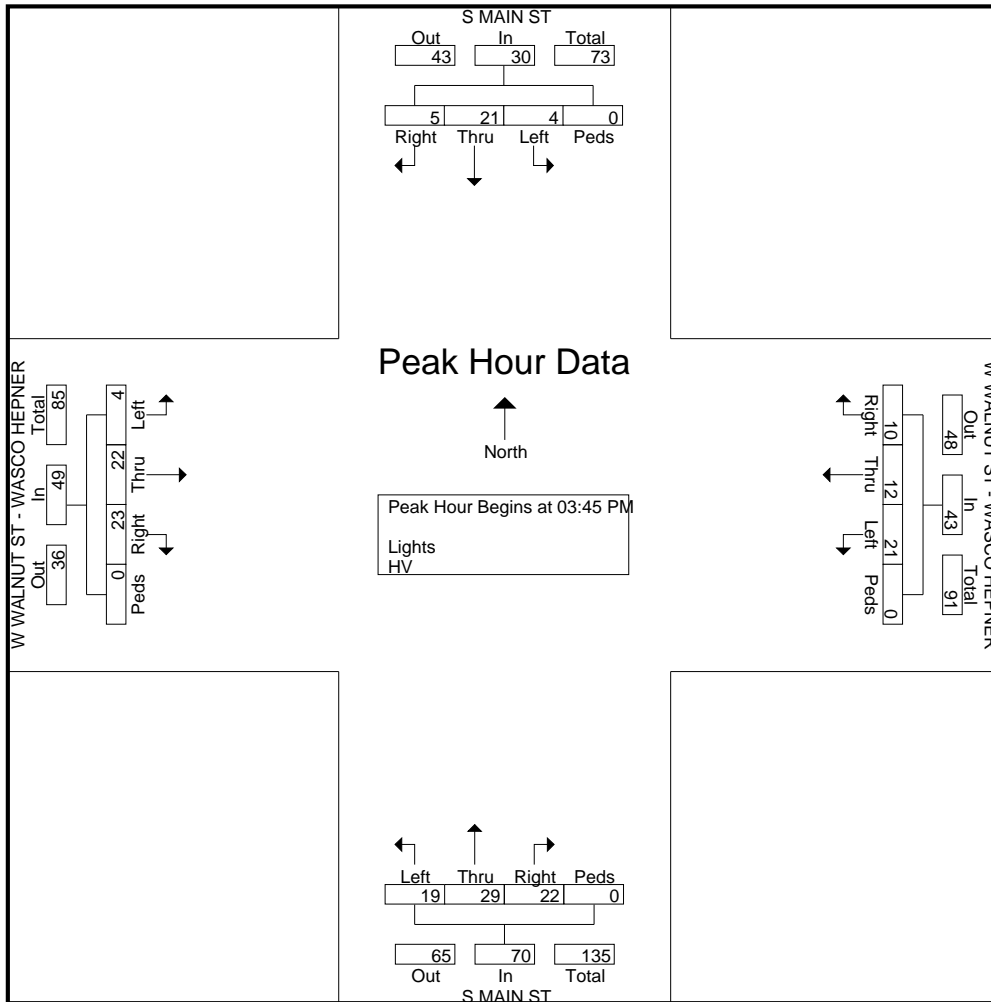

File Name : #2 MAIN&EBAYNARD
Site Code :
Start Date : 11/19/2014
Page No : 1

Groups Printed- Lights - HV

Start Time	MAIN ST Southbound				E BAYNARD ST Westbound				MAIN ST Northbound				ACCESS Eastbound				Int. Total	
	Right	Thru	Left	Peds	Right	Thru	Left	Peds	Right	Thru	Left	Peds	Right	Thru	Left	Peds		
05:00 AM	0	1	0	0	1	0	0	0	0	1	0	0	0	0	0	0	1	4
05:15 AM	0	1	1	0	0	0	0	0	0	0	0	0	0	0	0	0	0	2
05:30 AM	0	0	1	0	0	0	0	0	0	1	0	0	0	0	0	0	0	2
05:45 AM	0	1	0	0	0	0	0	0	0	0	0	0	0	0	0	0	0	1
Total	0	3	2	0	1	0	0	0	0	2	0	0	0	0	0	1	1	9
06:00 AM	1	4	2	0	0	0	0	0	0	0	0	0	0	0	1	1	1	9
06:15 AM	1	0	0	0	0	0	0	0	0	5	0	0	0	1	1	0	0	8
06:30 AM	0	1	0	0	3	0	2	0	0	5	0	0	0	0	1	1	1	13
06:45 AM	0	2	2	0	1	1	0	0	2	3	0	0	0	0	1	1	1	13
Total	2	7	4	0	4	1	2	0	2	13	0	0	0	1	4	3	3	43
07:00 AM	0	3	1	0	1	0	0	0	0	4	0	0	0	0	2	1	1	12
07:15 AM	0	3	2	0	1	0	0	0	0	4	0	0	1	1	0	0	0	12
07:30 AM	0	0	3	0	3	0	0	0	1	6	0	0	0	0	0	1	1	14
07:45 AM	3	7	7	0	10	0	1	0	2	17	0	0	0	0	0	0	0	47
Total	3	13	13	0	15	0	1	0	3	31	0	0	1	1	2	2	2	85
08:00 AM	3	2	1	0	2	0	0	0	0	3	0	0	0	0	0	1	1	12
08:15 AM	0	4	1	0	4	0	2	0	1	5	0	0	0	0	0	0	0	17
08:30 AM	0	4	2	0	3	0	0	0	0	3	0	0	0	0	2	0	0	14
08:45 AM	2	2	2	0	3	0	2	0	1	6	0	0	0	0	0	0	0	18
Total	5	12	6	0	12	0	4	0	2	17	0	0	0	0	2	1	1	61
09:00 AM	2	1	1	0	2	0	0	0	0	4	0	0	1	1	2	1	1	15
09:15 AM	0	2	2	0	2	0	0	0	0	6	0	0	2	0	0	0	0	14
09:30 AM	1	7	2	0	1	0	0	0	0	4	0	0	0	0	0	0	0	15
09:45 AM	0	2	2	0	1	0	0	0	0	7	0	0	0	0	1	0	0	13
Total	3	12	7	0	6	0	0	0	0	21	0	0	3	1	3	1	1	57
10:00 AM	2	8	1	0	4	0	0	0	0	6	1	0	0	0	1	0	0	23
10:15 AM	1	4	5	0	3	0	0	0	0	4	0	0	0	0	1	0	0	18
10:30 AM	2	2	1	0	2	0	0	0	0	6	0	0	0	0	1	0	0	14
10:45 AM	1	6	1	0	2	0	2	0	0	2	0	0	0	0	2	0	0	16
Total	6	20	8	0	11	0	2	0	0	18	1	0	0	0	5	0	0	71
11:00 AM	1	1	3	0	4	0	0	0	2	10	0	0	0	0	0	0	0	21
11:15 AM	3	6	4	0	1	0	0	0	0	3	1	0	0	0	1	0	0	19
11:30 AM	1	4	4	0	1	0	0	0	0	5	1	0	0	0	3	0	0	19
11:45 AM	2	4	1	0	2	0	0	0	2	4	0	0	0	0	1	0	0	16
Total	7	15	12	0	8	0	0	0	4	22	2	0	0	0	5	0	0	75
12:00 PM	5	11	3	0	2	0	0	0	3	7	1	0	2	0	5	0	0	39
12:15 PM	0	4	6	0	5	0	0	0	1	4	1	0	0	0	2	2	2	25
12:30 PM	2	2	7	3	4	1	0	1	0	4	0	0	1	0	2	2	2	29
12:45 PM	2	4	2	6	3	0	0	0	0	7	0	0	0	0	7	0	0	31
Total	9	21	18	9	14	1	0	1	4	22	2	0	3	0	16	4	4	124
01:00 PM	0	7	1	0	6	0	1	0	1	6	0	0	1	0	4	0	0	27
01:15 PM	0	2	2	0	3	0	0	0	0	4	2	0	0	0	2	0	0	15
01:30 PM	1	5	3	0	2	0	1	0	0	6	1	0	0	0	1	0	0	20
01:45 PM	0	4	2	0	0	0	0	10	1	6	0	1	0	0	2	0	0	26
Total	1	18	8	0	11	0	2	10	2	22	3	1	1	0	9	0	0	88

Groups Printed- Lights - HV

Start Time	MAIN ST Southbound				E BAYNARD ST Westbound				MAIN ST Northbound				ACCESS Eastbound				Int. Total
	Right	Thru	Left	Peds	Right	Thru	Left	Peds	Right	Thru	Left	Peds	Right	Thru	Left	Peds	
02:00 PM	0	9	3	0	1	0	2	0	0	4	0	1	2	0	2	0	24
02:15 PM	1	2	4	0	4	0	2	0	3	4	1	0	1	0	0	0	22
02:30 PM	1	8	2	0	2	0	0	10	0	6	0	0	1	1	1	0	32
02:45 PM	1	7	4	0	4	0	0	0	0	4	3	0	1	0	3	0	27
Total	3	26	13	0	11	0	4	10	3	18	4	1	5	1	6	0	105
03:00 PM	2	6	6	0	3	1	1	0	0	7	0	0	0	0	2	0	28
03:15 PM	1	2	6	0	4	0	1	0	0	3	0	0	0	0	7	0	24
03:30 PM	1	11	5	0	2	0	0	0	0	8	0	0	1	1	4	0	33
03:45 PM	1	6	2	0	8	0	1	2	1	9	0	4	0	0	3	0	37
Total	5	25	19	0	17	1	3	2	1	27	0	4	1	1	16	0	122
04:00 PM	3	8	6	0	0	0	0	0	1	0	0	0	0	0	2	0	20
04:15 PM	0	2	1	0	6	0	0	1	1	8	0	0	0	0	2	0	21
04:30 PM	2	3	7	0	3	0	3	0	0	6	1	1	0	0	3	0	29
04:45 PM	1	10	2	0	4	0	0	0	1	4	0	0	0	0	1	0	23
Total	6	23	16	0	13	0	3	1	3	18	1	1	0	0	8	0	93
05:00 PM	0	14	1	0	1	0	0	0	0	3	0	0	0	0	5	0	24
05:15 PM	0	4	1	0	4	1	1	0	0	9	0	0	0	0	0	0	20
05:30 PM	1	5	5	0	3	0	0	0	0	2	0	0	0	0	2	1	19
05:45 PM	2	2	2	0	4	0	0	0	0	3	0	0	1	0	1	0	15
Total	3	25	9	0	12	1	1	0	0	17	0	0	1	0	8	1	78
06:00 PM	2	2	2	0	2	0	0	0	0	5	0	0	0	0	2	0	15
06:15 PM	0	2	4	0	3	0	0	0	0	6	0	0	0	0	0	0	15
06:30 PM	1	6	2	0	5	0	1	0	0	0	0	0	1	0	1	0	17
06:45 PM	1	1	2	0	2	0	0	0	0	0	0	0	0	0	0	0	6
Total	4	11	10	0	12	0	1	0	0	11	0	0	1	0	3	0	53
07:00 PM	0	1	3	0	5	0	1	0	1	2	0	0	0	0	1	0	14
07:15 PM	1	3	1	0	0	0	1	0	0	1	0	0	0	0	0	0	7
07:30 PM	0	0	3	0	1	0	0	0	0	0	0	0	0	0	0	0	4
07:45 PM	0	1	0	0	1	0	0	0	0	2	0	0	0	0	0	0	4
Total	1	5	7	0	7	0	2	0	1	5	0	0	0	0	1	0	29
08:00 PM	0	6	2	0	0	0	0	0	1	2	0	0	0	0	0	0	11
08:15 PM	0	2	4	0	0	0	0	0	0	2	0	0	0	0	0	0	8
08:30 PM	0	5	0	0	1	0	0	0	1	1	0	0	0	0	0	0	8
08:45 PM	0	0	0	0	0	0	0	0	0	0	0	0	0	0	0	0	0
Total	0	13	6	0	1	0	0	0	2	5	0	0	0	0	0	0	27
Grand Total	58	249	158	9	155	4	25	24	27	269	13	7	16	5	88	13	1120
Apprch %	12.2	52.5	33.3	1.9	74.5	1.9	12	11.5	8.5	85.1	4.1	2.2	13.1	4.1	72.1	10.7	
Total %	5.2	22.2	14.1	0.8	13.8	0.4	2.2	2.1	2.4	24	1.2	0.6	1.4	0.4	7.9	1.2	
Lights	48	235	154	9	150	3	24	24	26	253	12	7	16	5	75	13	1054
% Lights	82.8	94.4	97.5	100	96.8	75	96	100	96.3	94.1	92.3	100	100	100	85.2	100	94.1
HV	10	14	4	0	5	1	1	0	1	16	1	0	0	0	13	0	66
% HV	17.2	5.6	2.5	0	3.2	25	4	0	3.7	5.9	7.7	0	0	0	14.8	0	5.9

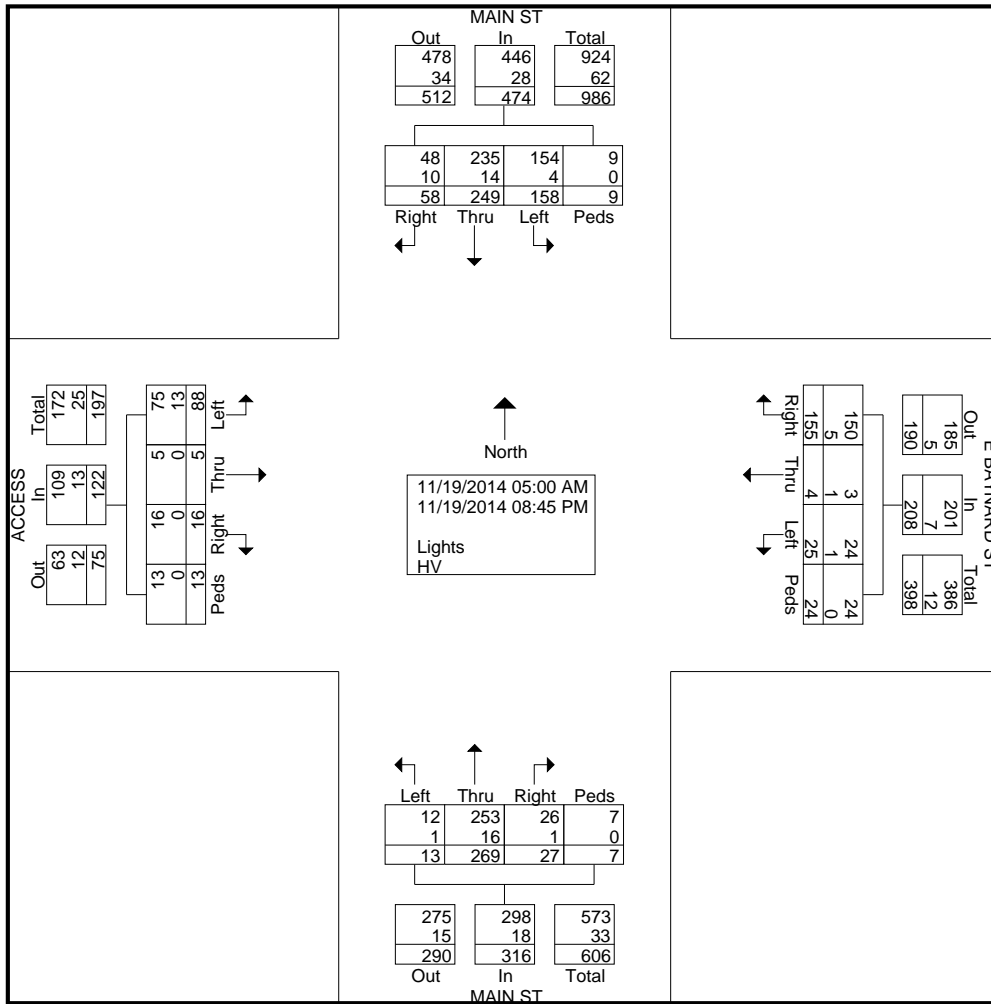

Start Time	MAIN ST Southbound					E BAYNARD ST Westbound					MAIN ST Northbound					ACCESS Eastbound					Int. Total
	Right	Thru	Left	Peds	App. Total	Right	Thru	Left	Peds	App. Total	Right	Thru	Left	Peds	App. Total	Right	Thru	Left	Peds	App. Total	
Peak Hour Analysis From 05:00 AM to 09:45 AM - Peak 1 of 1																					
Peak Hour for Entire Intersection Begins at 07:30 AM																					
07:30 AM	0	0	3	0	3	3	0	0	0	3	1	6	0	0	7	0	0	0	1	1	14
07:45 AM	3	7	7	0	17	10	0	1	0	11	2	17	0	0	19	0	0	0	0	0	47
08:00 AM	3	2	1	0	6	2	0	0	0	2	0	3	0	0	3	0	0	0	1	1	12
08:15 AM	0	4	1	0	5	4	0	2	0	6	1	5	0	0	6	0	0	0	0	0	17
Total Volume	6	13	12	0	31	19	0	3	0	22	4	31	0	0	35	0	0	0	2	2	90
% App. Total	19.4	41.9	38.7	0		86.4	0	13.6	0		11.4	88.6	0	0		0	0	0	100		
PHF	.500	.464	.429	.000	.456	.475	.000	.375	.000	.500	.500	.456	.000	.000	.461	.000	.000	.000	.500	.500	.479

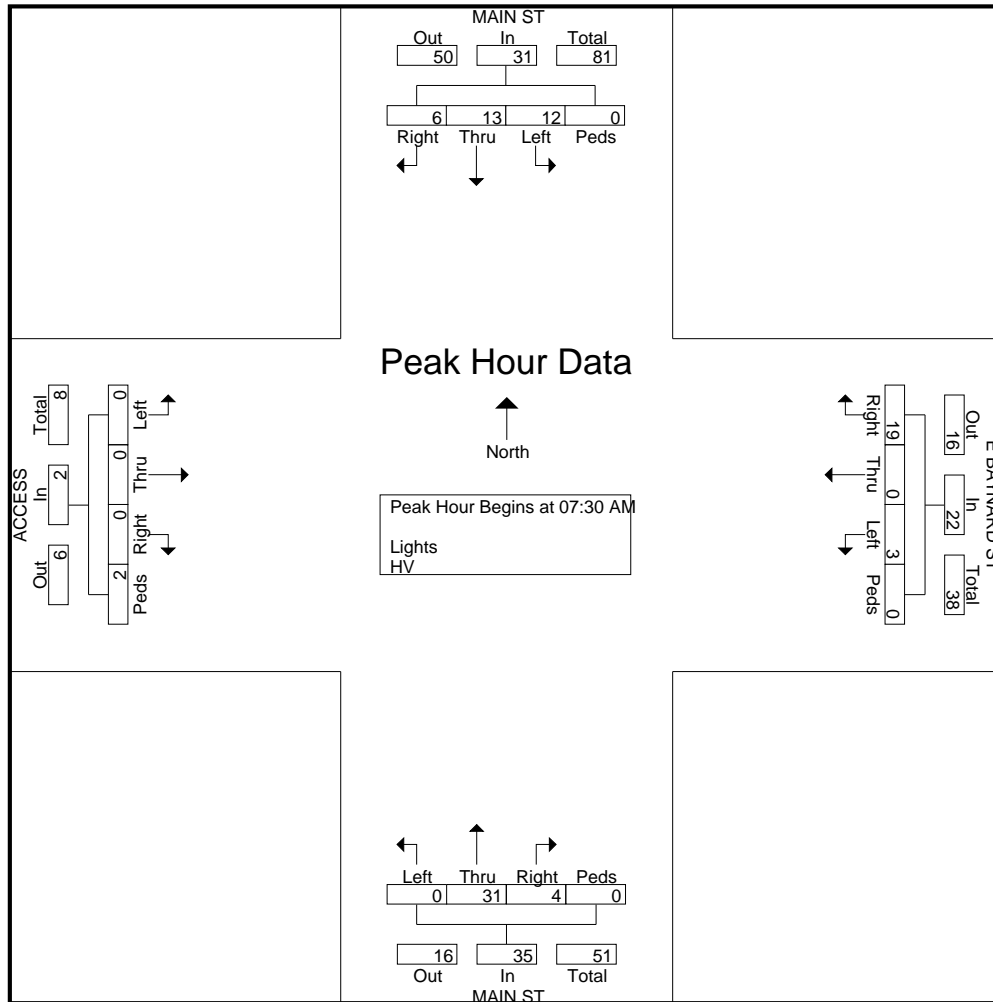

Peak Hour Analysis From 10:00 AM to 01:45 PM - Peak 1 of 1
Peak Hour for Entire Intersection Begins at 12:00 PM

12:00 PM	5	11	3	0	19	2	0	0	0	2	3	7	1	0	11	2	0	5	0	7	39
12:15 PM	0	4	6	0	10	5	0	0	0	5	1	4	1	0	6	0	0	2	2	4	25
12:30 PM	2	2	7	3	14	4	1	0	1	6	0	4	0	0	4	1	0	2	2	5	29
12:45 PM	2	4	2	6	14	3	0	0	0	3	0	7	0	0	7	0	0	7	0	7	31
Total Volume	9	21	18	9	57	14	1	0	1	16	4	22	2	0	28	3	0	16	4	23	124
% App. Total	15.8	36.8	31.6	15.8		87.5	6.2	0	6.2		14.3	78.6	7.1	0		13	0	69.6	17.4		
PHF	.450	.477	.643	.375	.750	.700	.250	.000	.250	.667	.333	.786	.500	.000	.636	.375	.000	.571	.500	.821	.795

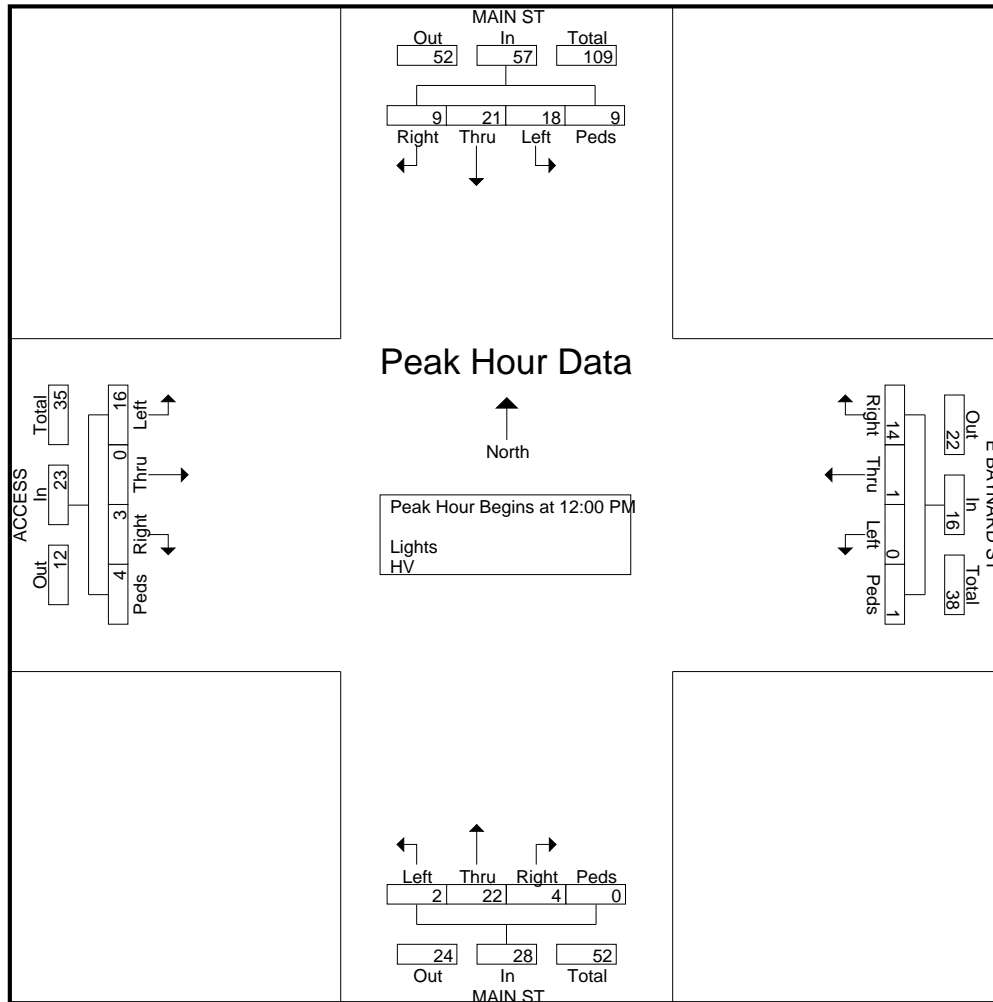

Peak Hour Analysis From 02:00 PM to 08:45 PM - Peak 1 of 1
Peak Hour for Entire Intersection Begins at 03:00 PM

03:00 PM	2	6	6	0	14	3	1	1	0	5	0	7	0	0	7	0	0	2	0	2	28
03:15 PM	1	2	6	0	9	4	0	1	0	5	0	3	0	0	3	0	0	7	0	7	24
03:30 PM	1	11	5	0	17	2	0	0	0	2	0	8	0	0	8	1	1	4	0	6	33
03:45 PM	1	6	2	0	9	8	0	1	2	11	1	9	0	4	14	0	0	3	0	3	37
Total Volume	5	25	19	0	49	17	1	3	2	23	1	27	0	4	32	1	1	16	0	18	122
% App. Total	10.2	51	38.8	0		73.9	4.3	13	8.7		3.1	84.4	0	12.5		5.6	5.6	88.9	0		
PHF	.625	.568	.792	.000	.721	.531	.250	.750	.250	.523	.250	.750	.000	.250	.571	.250	.250	.571	.000	.643	.824

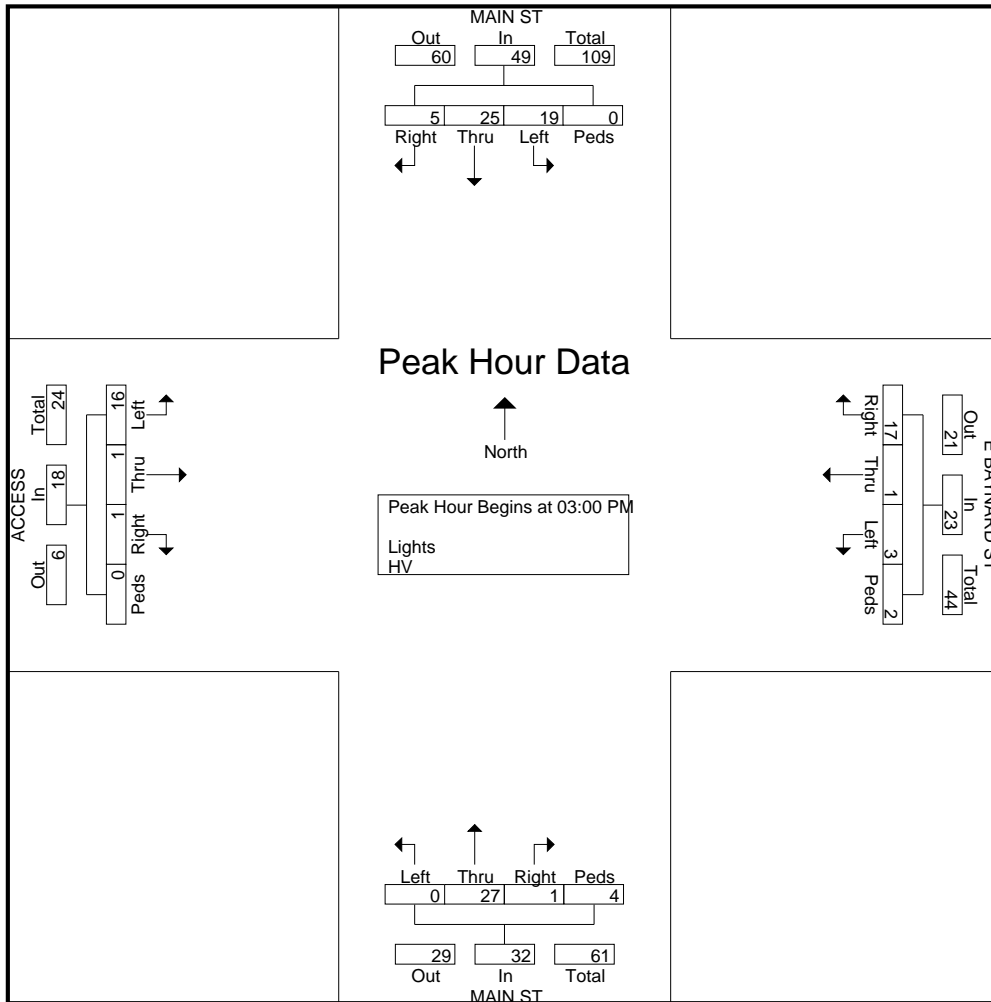

File Name : #3 COTTONWOOD&BEECH
Site Code :
Start Date : 11/19/2014
Page No : 1

Groups Printed- Lights - HV

Start Time	COTTONWOOD ST Southbound				I-84 RAMPS Westbound				COTTONWOOD ST Northbound				I-84 RAMPS Eastbound				Int. Total
	Right	Thru	Left	Peds	Right	Thru	Left	Peds	Right	Thru	Left	Peds	Right	Thru	Left	Peds	
05:00 AM	0	0	0	0	0	1	2	0	0	1	0	0	0	1	0	0	5
05:15 AM	0	0	0	0	0	1	2	0	1	0	0	0	1	0	0	0	5
05:30 AM	0	0	0	0	0	1	2	0	3	1	1	0	1	0	1	0	10
05:45 AM	1	0	0	0	0	0	0	0	1	0	1	0	1	2	0	0	6
Total	1	0	0	0	0	3	6	0	5	2	2	0	3	3	1	0	26
06:00 AM	0	0	0	0	0	0	0	0	0	1	0	0	2	3	0	0	6
06:15 AM	0	0	0	0	0	0	0	0	2	1	1	0	0	4	0	0	8
06:30 AM	2	1	0	0	0	2	2	0	4	1	0	0	1	2	0	0	15
06:45 AM	1	1	0	0	0	1	3	0	2	0	0	0	2	0	0	0	10
Total	3	2	0	0	0	3	5	0	8	3	1	0	5	9	0	0	39
07:00 AM	0	0	0	0	0	1	2	0	1	1	0	0	0	1	0	0	6
07:15 AM	0	0	0	0	0	2	5	0	4	1	2	0	0	2	0	0	16
07:30 AM	1	1	0	0	0	2	2	0	0	0	1	0	2	1	1	0	11
07:45 AM	0	0	0	0	0	3	2	0	4	0	0	0	0	2	1	0	12
Total	1	1	0	0	0	8	11	0	9	2	3	0	2	6	2	0	45
08:00 AM	1	0	0	0	0	1	1	0	5	1	0	0	0	1	3	0	13
08:15 AM	1	0	0	0	0	4	1	0	2	1	0	0	2	4	3	0	18
08:30 AM	1	1	0	0	0	3	1	0	3	0	2	0	2	3	0	0	16
08:45 AM	1	0	0	0	0	4	2	0	2	0	2	0	1	3	0	0	15
Total	4	1	0	0	0	12	5	0	12	2	4	0	5	11	6	0	62
09:00 AM	2	0	0	0	0	2	2	0	1	0	5	0	1	3	0	0	16
09:15 AM	0	0	0	0	0	5	5	0	0	0	3	0	5	3	1	0	22
09:30 AM	1	0	0	0	0	1	3	0	3	1	0	0	2	4	1	0	16
09:45 AM	0	1	0	0	0	3	5	0	1	0	3	0	0	3	1	0	17
Total	3	1	0	0	0	11	15	0	5	1	11	0	8	13	3	0	71
10:00 AM	0	0	0	0	1	2	0	0	3	0	1	1	1	5	1	0	15
10:15 AM	0	1	0	0	1	2	1	0	2	0	4	0	1	3	1	0	16
10:30 AM	0	1	0	0	0	2	0	0	1	2	3	0	1	3	1	0	14
10:45 AM	2	1	1	0	0	1	1	0	1	1	2	0	0	3	2	0	15
Total	2	3	1	0	2	7	2	0	7	3	10	1	3	14	5	0	60
11:00 AM	1	1	0	0	0	2	7	0	1	2	2	0	2	6	0	0	24
11:15 AM	0	1	0	0	0	3	5	0	5	0	2	0	0	6	0	0	22
11:30 AM	3	0	1	0	0	1	2	0	2	1	1	0	1	2	0	0	14
11:45 AM	1	0	0	0	0	0	1	0	2	0	1	0	0	6	1	0	12
Total	5	2	1	0	0	6	15	0	10	3	6	0	3	20	1	0	72
12:00 PM	6	3	0	0	0	4	3	0	3	1	3	0	3	6	2	0	34
12:15 PM	1	0	0	0	0	1	2	0	2	0	0	0	4	5	1	0	16
12:30 PM	1	1	0	0	2	1	1	0	4	1	1	1	5	5	2	1	26
12:45 PM	1	4	0	0	0	2	1	0	2	0	4	0	2	1	1	0	18
Total	9	8	0	0	2	8	7	0	11	2	8	1	14	17	6	1	94
01:00 PM	1	0	0	0	1	4	2	0	4	0	3	0	1	4	0	1	21
01:15 PM	2	0	0	0	0	5	1	0	3	0	1	1	4	5	2	0	24
01:30 PM	2	0	0	0	0	3	2	0	2	0	3	0	2	6	1	0	21
01:45 PM	1	0	0	0	0	1	2	0	2	0	4	0	2	3	0	0	15
Total	6	0	0	0	1	13	7	0	11	0	11	1	9	18	3	1	81

File Name : #3 COTTONWOOD&BEECH
Site Code :
Start Date : 11/19/2014
Page No : 2

Groups Printed- Lights - HV

Start Time	COTTONWOOD ST Southbound				I-84 RAMPS Westbound				COTTONWOOD ST Northbound				I-84 RAMPS Eastbound				Int. Total
	Right	Thru	Left	Peds	Right	Thru	Left	Peds	Right	Thru	Left	Peds	Right	Thru	Left	Peds	
02:00 PM	1	1	0	0	1	3	0	0	2	0	3	0	2	3	1	0	17
02:15 PM	3	1	0	0	0	3	6	0	0	1	3	0	3	4	2	0	26
02:30 PM	2	0	0	0	0	4	1	0	2	0	2	0	2	4	0	1	18
02:45 PM	1	0	0	0	0	3	3	0	2	0	1	0	4	4	2	0	20
Total	7	2	0	0	1	13	10	0	6	1	9	0	11	15	5	1	81
03:00 PM	4	0	0	0	0	2	0	0	1	2	3	0	2	4	0	0	18
03:15 PM	1	0	0	0	0	5	1	0	1	2	3	0	5	5	1	0	24
03:30 PM	0	0	0	0	0	5	1	0	3	0	3	0	0	1	0	2	15
03:45 PM	2	0	0	0	0	5	3	0	2	0	2	0	1	6	0	0	21
Total	7	0	0	0	0	17	5	0	7	4	11	0	8	16	1	2	78
04:00 PM	1	1	0	0	0	5	3	0	6	0	2	0	0	2	3	0	23
04:15 PM	0	1	0	0	0	4	2	0	5	1	2	0	1	4	1	0	21
04:30 PM	1	0	0	0	0	4	1	0	4	1	0	1	2	1	0	0	15
04:45 PM	0	0	0	0	0	7	2	0	3	0	4	0	3	1	0	0	20
Total	2	2	0	0	0	20	8	0	18	2	8	1	6	8	4	0	79
05:00 PM	1	0	0	0	1	1	2	0	3	0	0	0	2	6	0	0	16
05:15 PM	2	1	1	0	0	5	5	0	1	0	1	0	3	3	1	0	23
05:30 PM	2	0	0	0	0	4	1	0	2	0	5	0	5	6	2	0	27
05:45 PM	0	0	0	0	0	1	1	0	2	0	1	0	1	2	0	0	8
Total	5	1	1	0	1	11	9	0	8	0	7	0	11	17	3	0	74
06:00 PM	0	0	0	0	0	1	2	0	1	0	3	0	2	4	1	0	14
06:15 PM	0	0	0	0	0	3	2	0	2	0	1	0	2	1	0	0	11
06:30 PM	0	0	0	0	0	1	5	0	0	0	0	0	4	1	0	0	11
06:45 PM	0	0	0	0	0	1	1	0	0	0	1	0	0	0	0	0	3
Total	0	0	0	0	0	6	10	0	3	0	5	0	8	6	1	0	39
07:00 PM	0	0	0	0	0	1	3	0	0	0	0	0	1	4	0	0	9
07:15 PM	1	0	0	0	0	1	0	0	1	1	2	0	4	0	0	0	10
07:30 PM	0	0	0	0	0	0	1	0	0	0	1	0	1	0	0	0	3
07:45 PM	0	0	0	0	0	0	0	0	2	0	0	0	0	0	1	0	3
Total	1	0	0	0	0	2	4	0	3	1	3	0	6	4	1	0	25
08:00 PM	0	1	0	0	0	1	1	0	0	0	0	0	0	2	1	0	6
08:15 PM	0	0	0	0	0	0	0	0	0	0	0	0	2	0	0	0	2
08:30 PM	1	0	0	0	0	1	0	0	0	0	0	0	1	1	0	0	4
08:45 PM	0	0	0	0	0	1	0	0	2	0	0	0	1	1	0	0	5
Total	1	1	0	0	0	3	1	0	2	0	0	0	4	4	1	0	17
Grand Total	57	24	3	0	7	143	120	0	125	26	99	4	106	181	43	5	943
Apprch %	67.9	28.6	3.6	0	2.6	53	44.4	0	49.2	10.2	39	1.6	31.6	54	12.8	1.5	
Total %	6	2.5	0.3	0	0.7	15.2	12.7	0	13.3	2.8	10.5	0.4	11.2	19.2	4.6	0.5	
Lights	39	23	3	0	6	134	88	0	82	23	94	4	104	161	29	5	795
% Lights	68.4	95.8	100	0	85.7	93.7	73.3	0	65.6	88.5	94.9	100	98.1	89	67.4	100	84.3
HV	18	1	0	0	1	9	32	0	43	3	5	0	2	20	14	0	148
% HV	31.6	4.2	0	0	14.3	6.3	26.7	0	34.4	11.5	5.1	0	1.9	11	32.6	0	15.7

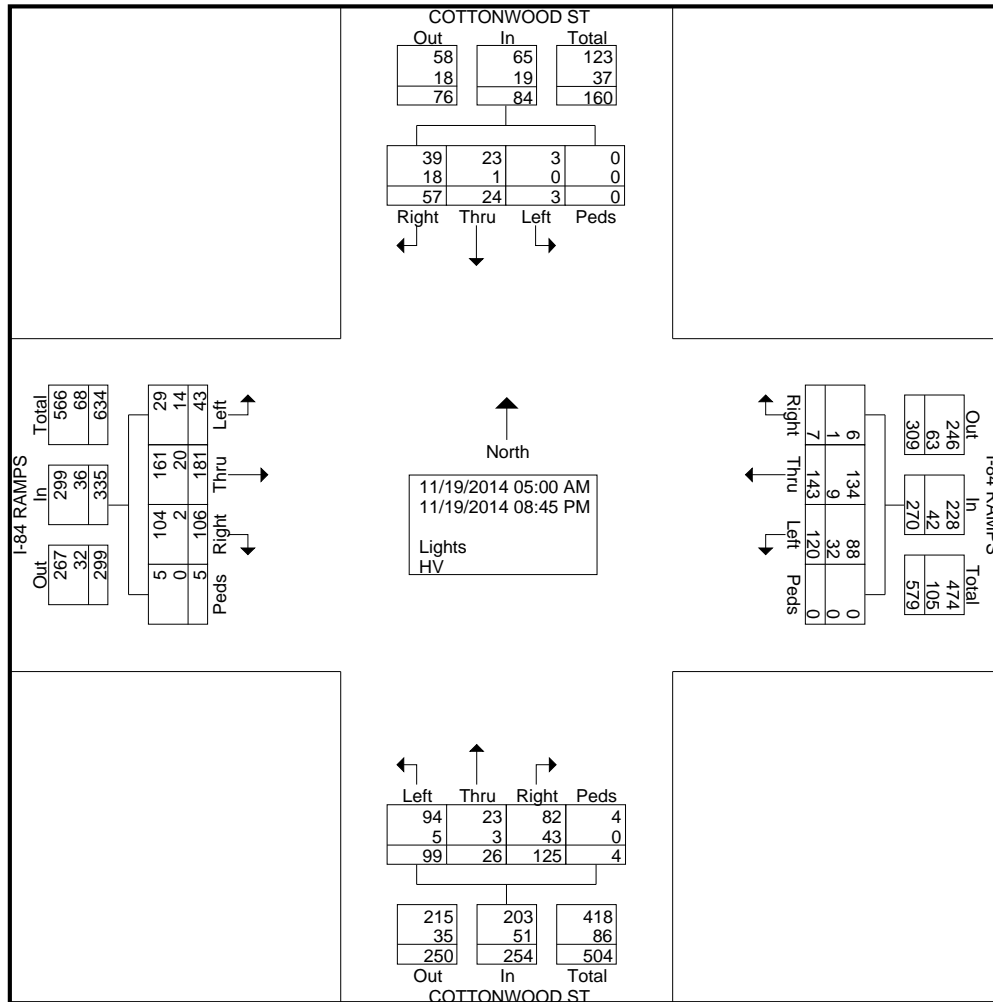

Start Time	COTTONWOOD ST Southbound					I-84 RAMPS Westbound					COTTONWOOD ST Northbound					I-84 RAMPS Eastbound					Int. Total
	Right	Thru	Left	Peds	App. Total	Right	Thru	Left	Peds	App. Total	Right	Thru	Left	Peds	App. Total	Right	Thru	Left	Peds	App. Total	
Peak Hour Analysis From 05:00 AM to 09:45 AM - Peak 1 of 1																					
Peak Hour for Entire Intersection Begins at 09:00 AM																					
09:00 AM	2	0	0	0	2	0	2	2	0	4	1	0	5	0	6	1	3	0	0	4	16
09:15 AM	0	0	0	0	0	0	5	5	0	10	0	0	3	0	3	5	3	1	0	9	22
09:30 AM	1	0	0	0	1	0	1	3	0	4	3	1	0	0	4	2	4	1	0	7	16
09:45 AM	0	1	0	0	1	0	3	5	0	8	1	0	3	0	4	0	3	1	0	4	17
Total Volume	3	1	0	0	4	0	11	15	0	26	5	1	11	0	17	8	13	3	0	24	71
% App. Total	75	25	0	0		0	42.3	57.7	0		29.4	5.9	64.7	0		33.3	54.2	12.5	0		
PHF	.375	.250	.000	.000	.500	.000	.550	.750	.000	.650	.417	.250	.550	.000	.708	.400	.813	.750	.000	.667	.807

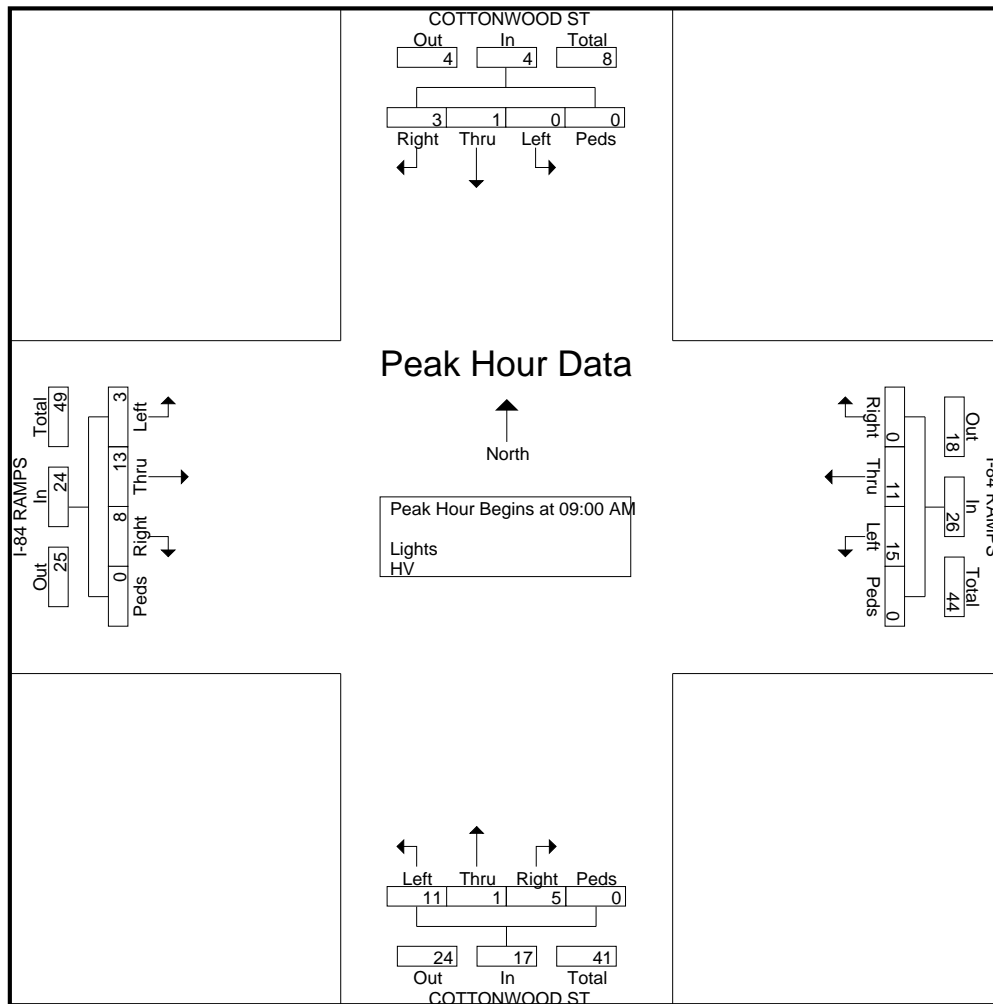

Peak Hour Analysis From 10:00 AM to 01:45 PM - Peak 1 of 1
Peak Hour for Entire Intersection Begins at 12:00 PM

12:00 PM	6	3	0	0	9	0	4	3	0	7	3	1	3	0	7	3	6	2	0	11	34
12:15 PM	1	0	0	0	1	0	1	2	0	3	2	0	0	0	2	4	5	1	0	10	16
12:30 PM	1	1	0	0	2	2	1	1	0	4	4	1	1	1	7	5	5	2	1	13	26
12:45 PM	1	4	0	0	5	0	2	1	0	3	2	0	4	0	6	2	1	1	0	4	18
Total Volume	9	8	0	0	17	2	8	7	0	17	11	2	8	1	22	14	17	6	1	38	94
% App. Total	52.9	47.1	0	0		11.8	47.1	41.2	0		50	9.1	36.4	4.5		36.8	44.7	15.8	2.6		
PHF	.375	.500	.000	.000	.472	.250	.500	.583	.000	.607	.688	.500	.500	.250	.786	.700	.708	.750	.250	.731	.691

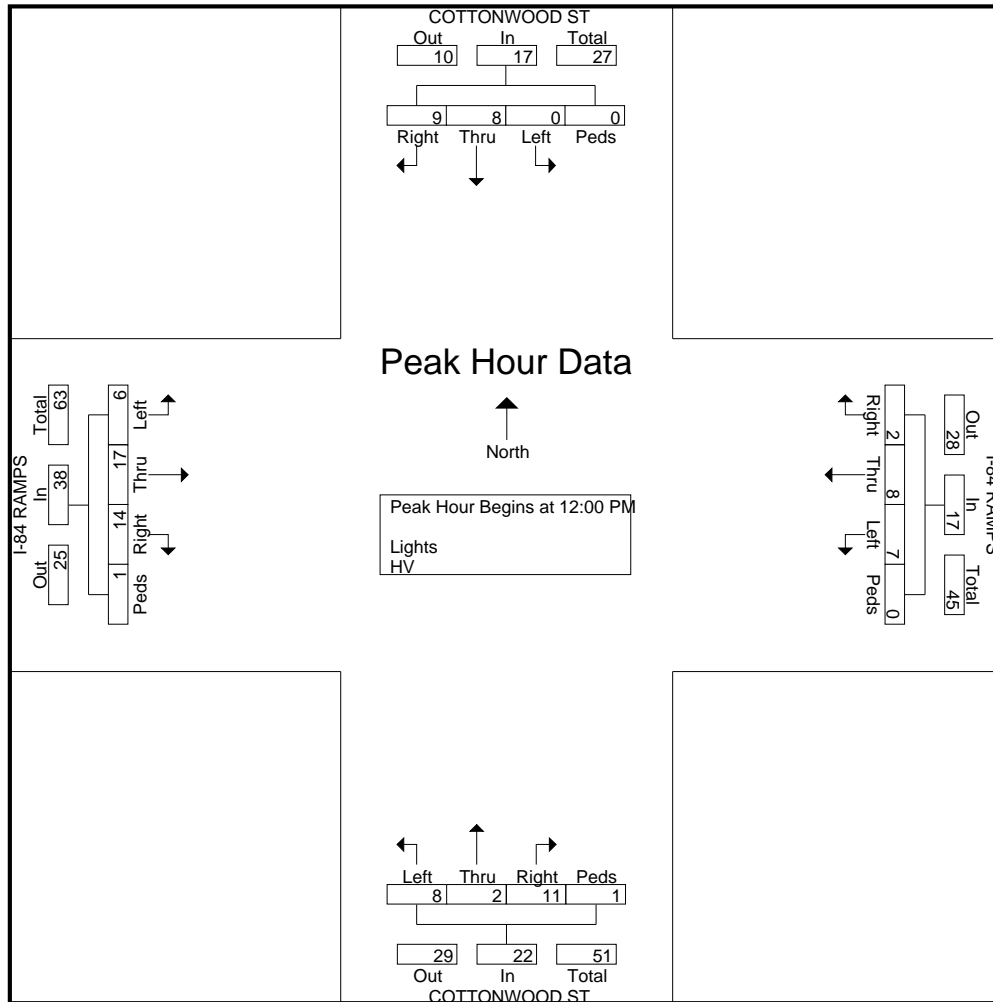

Peak Hour Analysis From 02:00 PM to 08:45 PM - Peak 1 of 1
Peak Hour for Entire Intersection Begins at 04:45 PM

04:45 PM	0	0	0	0	0	0	7	2	0	9	3	0	4	0	7	3	1	0	0	4	20
05:00 PM	1	0	0	0	1	1	1	2	0	4	3	0	0	0	3	2	6	0	0	8	16
05:15 PM	2	1	1	0	4	0	5	5	0	10	1	0	1	0	2	3	3	1	0	7	23
05:30 PM	2	0	0	0	2	0	4	1	0	5	2	0	5	0	7	5	6	2	0	13	27
Total Volume	5	1	1	0	7	1	17	10	0	28	9	0	10	0	19	13	16	3	0	32	86
% App. Total	71.4	14.3	14.3	0		3.6	60.7	35.7	0		47.4	0	52.6	0		40.6	50	9.4	0		
PHF	.625	.250	.250	.000	.438	.250	.607	.500	.000	.700	.750	.000	.500	.000	.679	.650	.667	.375	.000	.615	.796

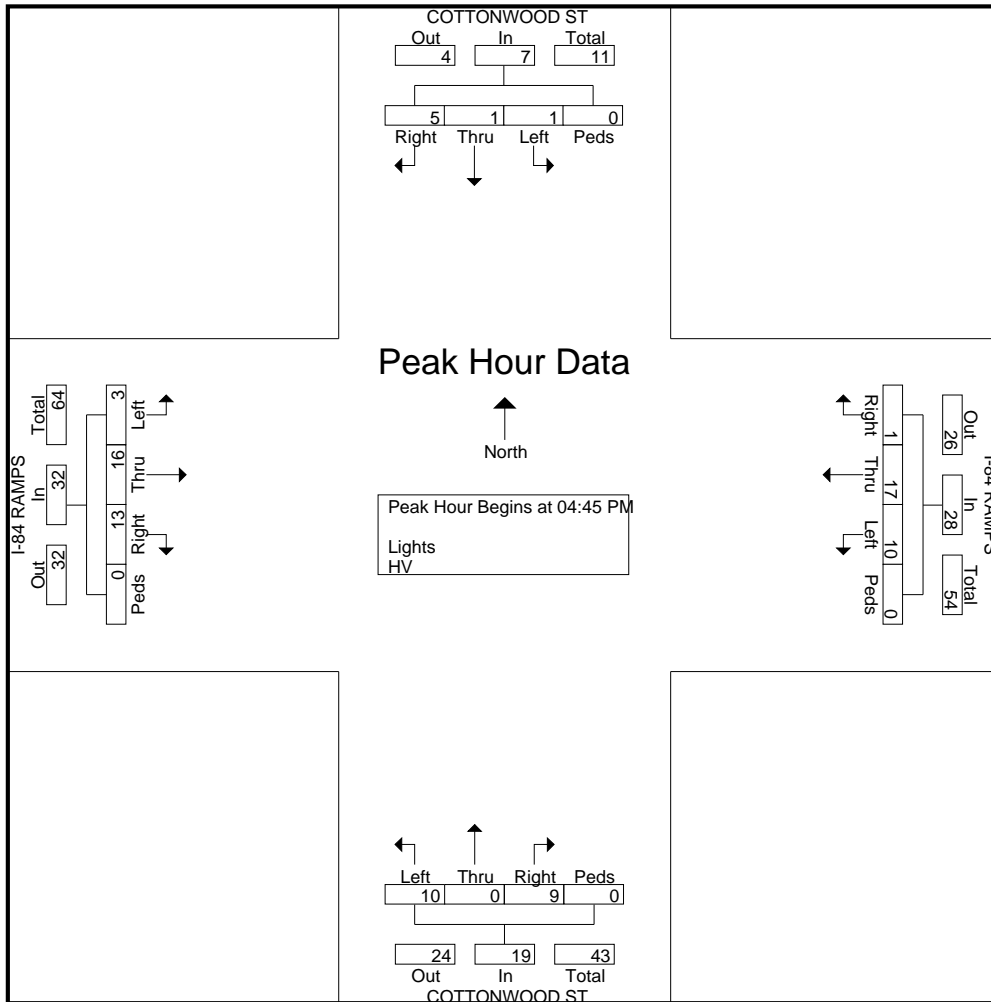

Groups Printed- Lights - HV

Start Time	I-84 RAMPS Southbound				BEECH ST Westbound				I-84 RAMPS Northbound				BEECH ST Eastbound				Int. Total
	Right	Thru	Left	Peds	Right	Thru	Left	Peds	Right	Thru	Left	Peds	Right	Thru	Left	Peds	
05:00 AM	0	2	0	0	1	0	4	0	0	1	0	0	0	0	0	0	8
05:15 AM	0	2	0	0	0	0	2	0	0	1	0	0	0	0	0	0	5
05:30 AM	0	1	0	0	1	0	0	0	1	1	0	0	0	0	0	0	4
05:45 AM	0	1	0	0	0	0	2	0	1	0	0	0	0	0	0	0	4
Total	0	6	0	0	2	0	8	0	2	3	0	0	0	0	0	0	21
06:00 AM	0	2	0	2	0	0	0	0	1	1	0	0	0	0	0	0	6
06:15 AM	0	10	0	1	0	0	2	0	0	2	0	0	0	0	0	0	15
06:30 AM	0	10	1	0	3	0	0	0	1	1	0	0	0	0	0	0	16
06:45 AM	0	11	0	0	1	0	1	0	0	3	0	0	0	0	0	0	16
Total	0	33	1	3	4	0	3	0	2	7	0	0	0	0	0	0	53
07:00 AM	2	3	0	2	1	0	1	0	1	2	0	0	0	0	0	0	12
07:15 AM	0	5	0	1	1	0	2	0	1	4	0	0	0	0	0	0	14
07:30 AM	0	5	2	0	3	0	3	0	1	3	0	0	0	0	0	0	17
07:45 AM	0	7	1	0	0	0	4	0	1	4	0	0	0	0	0	0	17
Total	2	20	3	3	5	0	10	0	4	13	0	0	0	0	0	0	60
08:00 AM	0	5	1	1	1	0	1	0	0	4	0	0	0	0	0	0	13
08:15 AM	0	8	2	0	0	0	5	0	2	0	0	0	0	0	0	0	17
08:30 AM	0	3	0	0	2	0	3	0	1	8	0	0	0	0	0	0	17
08:45 AM	0	6	0	0	3	0	4	0	2	2	0	0	0	0	0	0	17
Total	0	22	3	1	6	0	13	0	5	14	0	0	0	0	0	0	64
09:00 AM	1	4	1	1	2	0	2	0	3	6	0	0	0	0	0	0	20
09:15 AM	0	4	1	0	2	0	3	0	1	6	0	0	0	0	0	0	17
09:30 AM	0	5	7	0	4	0	2	0	0	4	0	0	0	0	0	0	22
09:45 AM	0	3	1	0	0	0	3	0	3	3	0	0	0	0	0	0	13
Total	1	16	10	1	8	0	10	0	7	19	0	0	0	0	0	0	72
10:00 AM	0	2	4	1	2	0	3	0	1	8	0	0	0	0	0	0	21
10:15 AM	0	5	1	0	3	1	3	0	1	3	0	0	0	0	0	0	17
10:30 AM	0	4	2	0	1	0	4	0	0	3	0	0	0	0	0	0	14
10:45 AM	0	5	3	0	2	0	1	0	2	2	0	0	0	0	0	0	15
Total	0	16	10	1	8	1	11	0	4	16	0	0	0	0	0	0	67
11:00 AM	0	7	1	1	2	0	3	2	2	1	0	2	0	0	0	0	21
11:15 AM	0	4	1	0	1	0	2	3	2	4	0	3	0	0	0	1	21
11:30 AM	0	4	2	0	7	0	2	0	2	3	0	0	0	0	0	0	20
11:45 AM	0	3	2	0	1	0	2	0	2	3	0	0	0	0	0	0	13
Total	0	18	6	1	11	0	9	5	8	11	0	5	0	0	0	1	75
12:00 PM	0	5	2	0	9	0	3	0	2	6	0	0	0	0	0	0	27
12:15 PM	0	2	2	0	3	0	2	0	3	4	0	0	0	0	0	0	16
12:30 PM	0	4	5	0	3	0	0	0	1	3	0	0	0	0	0	0	16
12:45 PM	0	4	0	0	1	0	3	0	2	3	0	0	0	0	0	0	13
Total	0	15	9	0	16	0	8	0	8	16	0	0	0	0	0	0	72
01:00 PM	0	8	2	0	4	0	3	0	1	5	0	0	0	0	0	0	23
01:15 PM	0	1	6	0	2	1	5	0	0	5	0	0	0	0	0	0	20
01:30 PM	0	5	6	0	3	0	1	1	0	1	0	0	0	0	0	0	17
01:45 PM	0	4	3	0	8	0	1	1	0	6	0	0	0	0	0	0	23
Total	0	18	17	0	17	1	10	2	1	17	0	0	0	0	0	0	83

Groups Printed- Lights - HV

Start Time	I-84 RAMPS Southbound				BEECH ST Westbound				I-84 RAMPS Northbound				BEECH ST Eastbound				Int. Total
	Right	Thru	Left	Peds	Right	Thru	Left	Peds	Right	Thru	Left	Peds	Right	Thru	Left	Peds	
02:00 PM	0	6	4	0	4	0	2	0	2	5	0	0	0	0	0	0	23
02:15 PM	0	2	5	0	3	0	0	0	2	2	0	0	0	0	0	0	14
02:30 PM	0	6	2	0	2	0	1	0	1	3	0	0	0	0	0	0	15
02:45 PM	0	4	3	0	4	0	1	0	5	7	0	0	0	0	0	0	24
Total	0	18	14	0	13	0	4	0	10	17	0	0	0	0	0	0	76
03:00 PM	0	1	1	0	4	0	7	0	1	5	0	0	0	0	0	0	19
03:15 PM	0	3	3	0	0	0	4	0	2	10	0	0	0	0	0	0	22
03:30 PM	0	6	1	0	4	0	2	0	0	6	0	0	0	0	0	0	19
03:45 PM	0	7	1	0	5	0	1	0	2	4	0	2	0	1	0	0	23
Total	0	17	6	0	13	0	14	0	5	25	0	2	0	1	0	0	83
04:00 PM	0	6	2	0	1	0	5	0	5	10	0	0	0	0	0	0	29
04:15 PM	0	2	1	0	1	0	6	0	1	6	0	0	0	0	0	0	17
04:30 PM	0	4	1	0	1	0	3	0	2	4	0	0	0	0	0	0	15
04:45 PM	0	5	0	0	1	0	3	0	3	2	0	0	0	0	0	0	14
Total	0	17	4	0	4	0	17	0	11	22	0	0	0	0	0	0	75
05:00 PM	0	4	0	0	2	0	2	0	4	5	0	0	0	0	0	0	17
05:15 PM	0	3	5	0	2	0	1	0	1	8	0	2	0	0	0	0	22
05:30 PM	0	4	4	0	4	0	3	0	4	2	0	0	0	0	0	0	21
05:45 PM	0	5	1	0	2	0	4	0	3	2	0	0	0	0	0	0	17
Total	0	16	10	0	10	0	10	0	12	17	0	2	0	0	0	0	77
06:00 PM	0	4	0	0	0	0	3	0	4	1	0	0	0	0	0	0	12
06:15 PM	0	1	0	0	0	0	1	0	3	2	0	0	0	0	0	0	7
06:30 PM	0	1	2	0	1	0	1	0	1	1	0	0	0	0	0	0	7
06:45 PM	0	3	0	0	1	0	3	0	0	0	0	0	0	0	0	0	7
Total	0	9	2	0	2	0	8	0	8	4	0	0	0	0	0	0	33
07:00 PM	0	2	1	0	1	0	3	0	4	1	0	0	0	0	0	0	12
07:15 PM	0	2	2	0	2	0	6	0	2	2	0	0	0	0	0	0	16
07:30 PM	0	1	0	0	0	0	3	0	0	3	0	0	0	0	0	0	7
07:45 PM	0	1	3	0	0	0	1	0	0	0	0	0	0	0	0	0	5
Total	0	6	6	0	3	0	13	0	6	6	0	0	0	0	0	0	40
08:00 PM	0	1	0	0	0	0	0	0	1	0	0	0	0	0	0	0	2
08:15 PM	0	3	0	0	0	0	1	0	0	0	0	0	0	0	0	0	4
08:30 PM	0	3	0	0	1	0	1	0	0	0	0	0	0	0	0	0	5
08:45 PM	0	0	0	0	0	0	0	0	1	1	0	0	0	0	0	0	2
Total	0	7	0	0	1	0	2	0	2	1	0	0	0	0	0	0	13
Grand Total	3	254	101	10	123	2	150	7	95	208	0	9	0	1	0	1	964
Apprch %	0.8	69	27.4	2.7	43.6	0.7	53.2	2.5	30.4	66.7	0	2.9	0	50	0	50	
Total %	0.3	26.3	10.5	1	12.8	0.2	15.6	0.7	9.9	21.6	0	0.9	0	0.1	0	0.1	
Lights	0	180	82	10	103	1	139	7	84	141	0	9	0	0	0	1	757
% Lights	0	70.9	81.2	100	83.7	50	92.7	100	88.4	67.8	0	100	0	0	0	100	78.5
HV	3	74	19	0	20	1	11	0	11	67	0	0	0	1	0	0	207
% HV	100	29.1	18.8	0	16.3	50	7.3	0	11.6	32.2	0	0	0	100	0	0	21.5

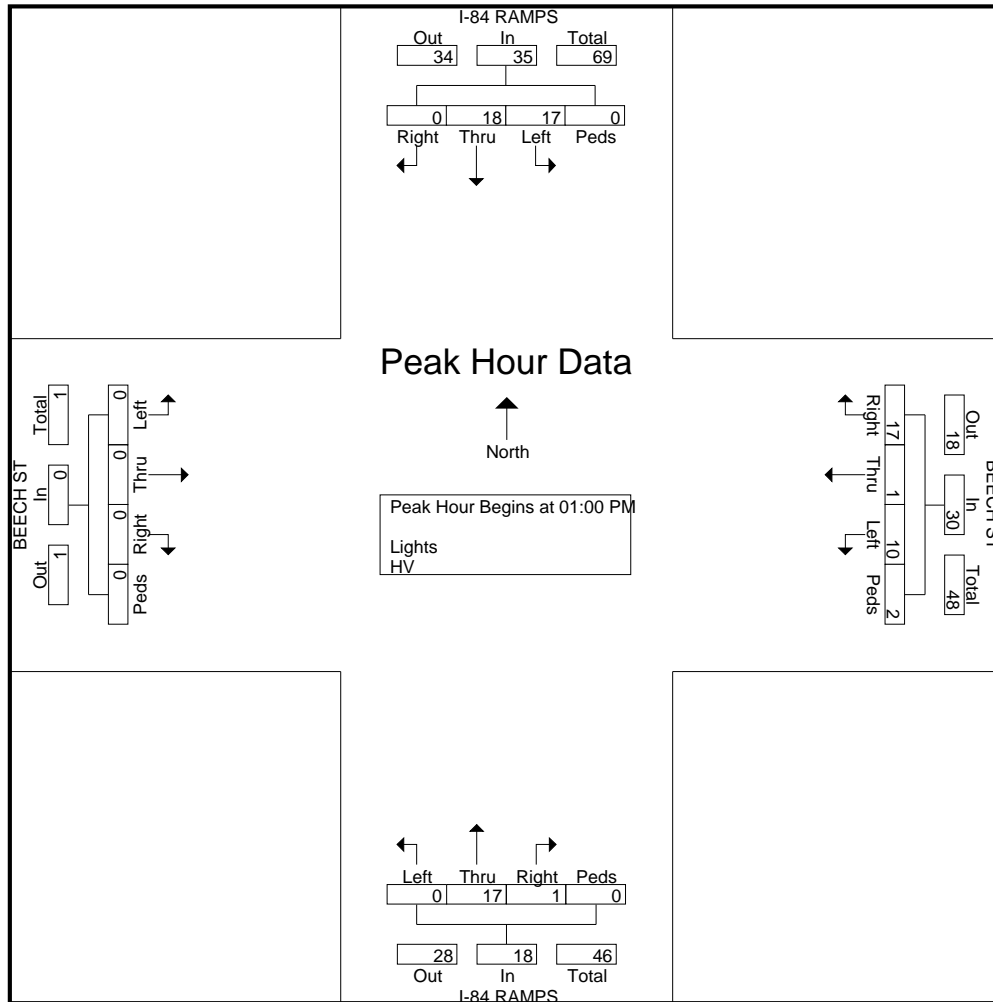

Peak Hour Analysis From 02:00 PM to 08:45 PM - Peak 1 of 1

Peak Hour for Entire Intersection Begins at 03:15 PM

03:15 PM	0	3	3	0	6	0	0	4	0	4	2	10	0	0	12	0	0	0	0	0	22
03:30 PM	0	6	1	0	7	4	0	2	0	6	0	6	0	0	6	0	0	0	0	0	19
03:45 PM	0	7	1	0	8	5	0	1	0	6	2	4	0	2	8	0	1	0	0	1	23
04:00 PM	0	6	2	0	8	1	0	5	0	6	5	10	0	0	15	0	0	0	0	0	29
Total Volume	0	22	7	0	29	10	0	12	0	22	9	30	0	2	41	0	1	0	0	1	93
% App. Total	0	75.9	24.1	0		45.5	0	54.5	0		22	73.2	0	4.9		0	100	0	0		
PHF	.000	.786	.583	.000	.906	.500	.000	.600	.000	.917	.450	.750	.000	.250	.683	.000	.250	.000	.000	.250	.802

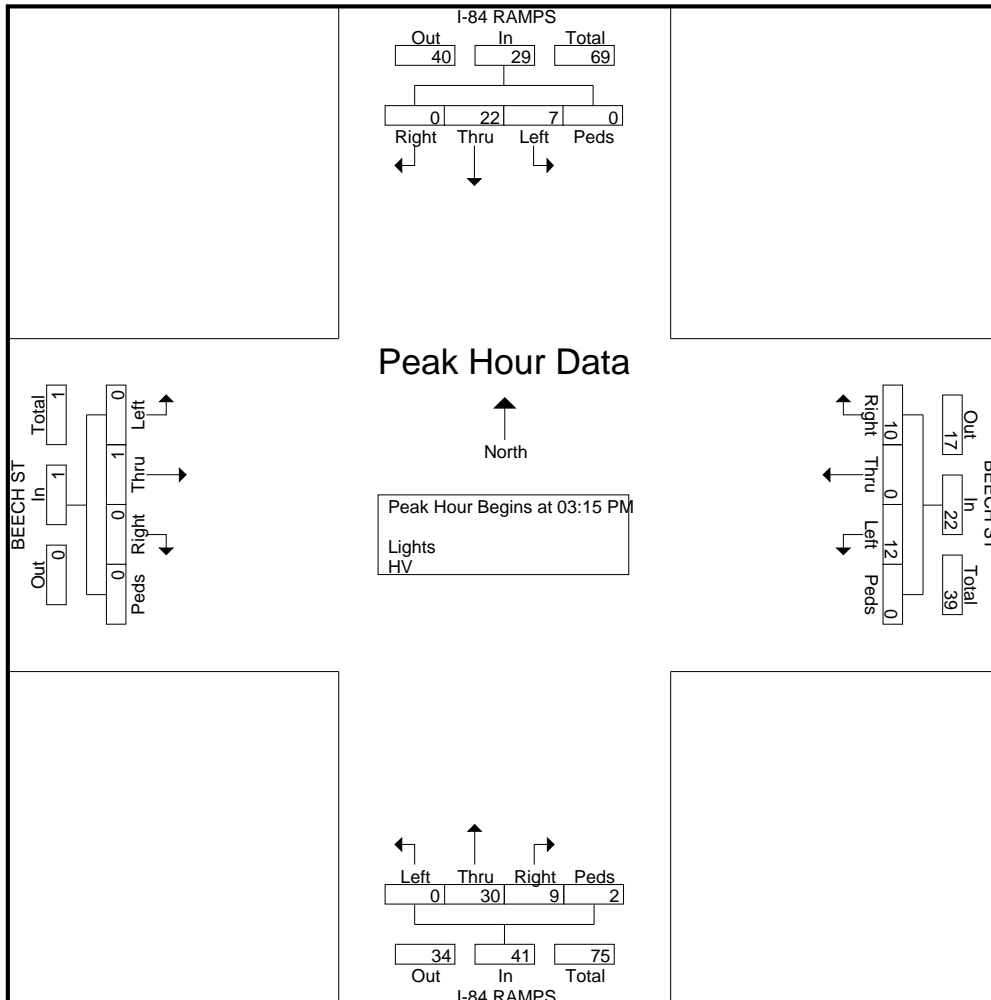

Groups Printed- Lights - HV

Start Time	OR 74 - HEPPNER HWY Southbound				I-84 EB RAMPS Westbound				OR 74 - HEPPNER HWY Northbound				I-84 EB RAMPS Eastbound				Int. Total
	Right	Thru	Left	Peds	Right	Thru	Left	Peds	Right	Thru	Left	Peds	Right	Thru	Left	Peds	
05:00 AM	0	0	0	0	0	0	0	0	1	0	0	0	0	2	0	0	3
05:15 AM	0	0	0	0	0	0	0	0	0	0	0	0	0	1	0	0	1
05:30 AM	0	1	0	0	0	0	0	0	1	0	0	0	0	0	0	0	2
05:45 AM	0	0	0	0	0	0	0	0	0	0	0	0	0	0	0	0	0
Total	0	1	0	0	0	0	0	0	2	0	0	0	0	3	0	0	6
06:00 AM	0	1	0	0	0	0	0	0	0	0	0	0	0	1	0	0	2
06:15 AM	0	2	0	0	0	0	0	0	1	0	0	0	0	0	0	0	3
06:30 AM	0	2	0	0	0	0	0	0	1	0	0	0	0	1	0	0	4
06:45 AM	0	1	0	0	0	0	0	0	0	0	0	0	1	2	0	0	4
Total	0	6	0	0	0	0	0	0	2	0	0	0	1	4	0	0	13
07:00 AM	0	1	0	0	0	0	0	0	1	0	0	0	0	1	0	0	3
07:15 AM	0	0	0	0	0	0	0	0	2	0	0	0	0	0	0	0	2
07:30 AM	0	3	0	0	0	0	0	0	0	0	0	0	0	0	0	0	3
07:45 AM	0	1	0	0	0	0	0	0	3	0	0	0	0	0	0	0	4
Total	0	5	0	0	0	0	0	0	6	0	0	0	0	1	0	0	12
08:00 AM	0	0	0	0	0	0	0	0	0	0	0	0	0	2	0	0	2
08:15 AM	0	0	0	0	0	0	0	0	1	0	0	0	1	0	0	0	2
08:30 AM	0	0	0	0	0	0	0	0	0	1	0	0	0	2	0	0	3
08:45 AM	0	0	0	0	0	0	0	0	2	1	0	0	0	0	0	0	3
Total	0	0	0	0	0	0	0	0	3	2	0	0	1	4	0	0	10
09:00 AM	0	0	0	0	0	0	0	0	3	1	0	0	0	0	0	0	4
09:15 AM	0	0	0	0	0	0	0	0	0	0	0	0	1	0	0	0	1
09:30 AM	0	0	0	0	0	0	0	0	0	1	0	0	2	1	0	0	4
09:45 AM	0	0	0	0	0	0	0	0	1	0	0	0	1	0	0	0	2
Total	0	0	0	0	0	0	0	0	4	2	0	0	4	1	0	0	11
10:00 AM	0	1	0	0	0	0	0	0	0	1	0	0	1	0	0	0	3
10:15 AM	0	0	1	0	0	0	0	0	0	1	0	0	1	0	0	0	3
10:30 AM	0	0	0	0	0	0	0	0	2	1	0	0	1	0	0	0	4
10:45 AM	0	1	0	0	0	0	0	0	0	2	0	0	0	0	0	0	3
Total	0	2	1	0	0	0	0	0	2	5	0	0	3	0	0	0	13
11:00 AM	0	0	0	0	0	0	0	0	0	1	0	0	0	0	0	0	1
11:15 AM	0	1	0	0	0	0	0	0	1	1	0	0	0	0	0	0	3
11:30 AM	0	0	0	0	0	0	0	0	0	0	0	0	1	1	0	0	2
11:45 AM	0	1	0	0	0	0	0	0	0	0	0	0	1	0	0	0	2
Total	0	2	0	0	0	0	0	0	1	2	0	0	2	1	0	0	8
12:00 PM	0	0	1	0	0	0	0	0	0	0	0	0	2	0	0	0	3
12:15 PM	0	0	0	0	0	0	0	0	1	0	0	0	1	1	0	0	3
12:30 PM	0	0	1	0	0	0	0	0	0	1	0	0	1	0	0	0	3
12:45 PM	0	0	0	0	0	0	0	0	0	1	0	0	1	1	0	0	3
Total	0	0	2	0	0	0	0	0	1	2	0	0	5	2	0	0	12
01:00 PM	0	2	1	0	0	0	0	0	0	1	0	0	0	1	0	0	5
01:15 PM	0	2	0	0	0	0	0	0	0	0	0	0	2	0	1	0	5
01:30 PM	0	0	0	0	0	0	0	0	0	2	0	0	0	2	0	0	4

Groups Printed- Lights - HV

Start Time	OR 74 - HEPPNER HWY Southbound				I-84 EB RAMPS Westbound				OR 74 - HEPPNER HWY Northbound				I-84 EB RAMPS Eastbound				Int. Total
	Right	Thru	Left	Peds	Right	Thru	Left	Peds	Right	Thru	Left	Peds	Right	Thru	Left	Peds	
01:45 PM	0	0	0	0	0	0	0	0	2	0	0	0	1	1	0	0	4
Total	0	4	1	0	0	0	0	0	2	3	0	0	3	4	1	0	18
02:00 PM	0	2	0	0	0	0	0	0	1	3	0	0	0	0	0	0	6
02:15 PM	0	1	0	0	0	0	0	0	1	0	0	0	1	0	0	0	3
02:30 PM	0	1	0	0	0	0	0	0	2	0	0	0	1	0	0	0	4
02:45 PM	0	1	0	0	0	0	0	0	3	1	0	0	1	0	0	0	6
Total	0	5	0	0	0	0	0	0	7	4	0	0	3	0	0	0	19
03:00 PM	0	1	0	0	0	0	0	0	1	0	0	0	2	0	0	0	4
03:15 PM	0	1	1	0	0	0	0	0	1	1	0	0	1	0	0	0	5
03:30 PM	0	1	0	0	0	0	0	0	0	1	0	0	0	0	0	0	2
03:45 PM	0	0	0	0	0	0	0	0	3	0	0	0	1	1	0	0	5
Total	0	3	1	0	0	0	0	0	5	2	0	0	4	1	0	0	16
04:00 PM	0	1	0	0	0	0	0	0	1	0	0	0	1	0	0	0	3
04:15 PM	0	0	0	0	0	0	0	0	0	0	0	0	1	1	1	0	3
04:30 PM	0	0	0	0	0	0	0	0	3	1	0	0	0	0	0	0	4
04:45 PM	0	1	0	0	0	0	0	0	0	1	0	0	1	0	0	0	3
Total	0	2	0	0	0	0	0	0	4	2	0	0	3	1	1	0	13
05:00 PM	0	0	0	0	0	0	0	0	0	1	0	0	0	1	0	0	2
05:15 PM	0	0	0	0	0	0	0	0	1	1	0	0	2	2	0	0	6
05:30 PM	0	0	0	0	0	0	0	0	2	1	0	0	0	0	0	0	3
05:45 PM	0	1	0	0	0	0	0	0	1	0	0	0	0	2	0	0	4
Total	0	1	0	0	0	0	0	0	4	3	0	0	2	5	0	0	15
06:00 PM	0	2	0	0	0	0	0	0	0	0	0	0	0	0	1	0	3
06:15 PM	0	0	0	0	0	0	0	0	0	0	0	0	0	2	0	0	2
06:30 PM	0	0	0	0	0	0	0	0	0	0	0	0	0	1	1	0	2
06:45 PM	0	0	0	0	0	0	0	0	0	1	0	0	0	1	0	0	2
Total	0	2	0	0	0	0	0	0	0	1	0	0	0	4	2	0	9
07:00 PM	0	0	0	0	0	0	0	0	0	0	0	0	0	0	0	0	0
07:15 PM	0	0	0	0	0	0	0	0	0	0	0	0	0	0	0	0	0
07:30 PM	0	0	0	0	0	0	0	0	0	0	0	0	1	0	0	0	1
07:45 PM	0	0	0	0	0	0	0	0	0	0	0	0	0	1	0	0	1
Total	0	0	0	0	0	0	0	0	0	0	0	0	1	1	0	0	2
08:00 PM	0	1	0	0	0	0	0	0	0	0	0	0	0	1	0	0	2
08:15 PM	0	0	0	0	0	0	0	0	0	0	0	0	0	0	0	0	0
08:30 PM	0	0	0	0	0	0	0	0	0	0	0	0	0	1	0	0	1
08:45 PM	0	0	0	0	0	0	0	0	0	0	0	0	0	1	0	0	1
Total	0	1	0	0	0	0	0	0	0	0	0	0	0	3	0	0	4
Grand Total	0	34	5	0	0	0	0	0	43	28	0	0	32	35	4	0	181
Apprch %	0	87.2	12.8	0	0	0	0	0	60.6	39.4	0	0	45.1	49.3	5.6	0	
Total %	0	18.8	2.8	0	0	0	0	0	23.8	15.5	0	0	17.7	19.3	2.2	0	
Lights	0	33	5	0	0	0	0	0	40	27	0	0	29	7	4	0	145
% Lights	0	97.1	100	0	0	0	0	0	93	96.4	0	0	90.6	20	100	0	80.1
HV	0	1	0	0	0	0	0	0	3	1	0	0	3	28	0	0	36
% HV	0	2.9	0	0	0	0	0	0	7	3.6	0	0	9.4	80	0	0	19.9

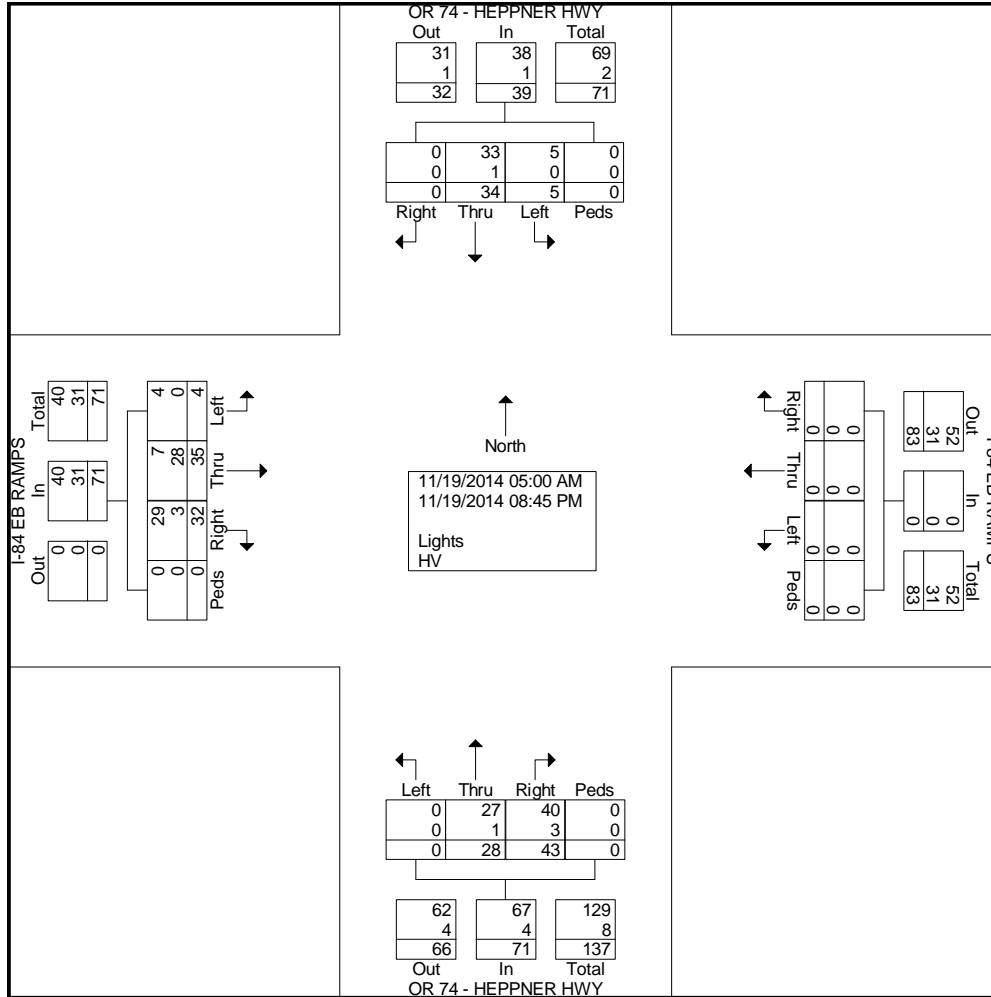

Start Time	OR 74 - HEPPNER HWY Southbound					I-84 EB RAMPS Westbound					OR 74 - HEPPNER HWY Northbound					I-84 EB RAMPS Eastbound					Int. Total
	Right	Thru	Left	Peds	App. Total	Right	Thru	Left	Peds	App. Total	Right	Thru	Left	Peds	App. Total	Right	Thru	Left	Peds	App. Total	
Peak Hour Analysis From 05:00 AM to 09:45 AM - Peak 1 of 1																					
Peak Hour for Entire Intersection Begins at 06:15 AM																					
06:15 AM	0	2	0	0	2	0	0	0	0	0	1	0	0	0	1	0	0	0	0	0	3
06:30 AM	0	2	0	0	2	0	0	0	0	0	1	0	0	0	1	0	1	0	0	1	4
06:45 AM	0	1	0	0	1	0	0	0	0	0	0	0	0	0	0	1	2	0	0	3	4
07:00 AM	0	1	0	0	1	0	0	0	0	0	1	0	0	0	1	0	1	0	0	1	3
Total Volume	0	6	0	0	6	0	0	0	0	0	3	0	0	0	3	1	4	0	0	5	14
% App. Total	0	100	0	0		0	0	0	0		100	0	0	0		20	80	0	0		
PHF	.000	.750	.000	.000	.750	.000	.000	.000	.000	.000	.750	.000	.000	.000	.750	.250	.500	.000	.000	.417	.875

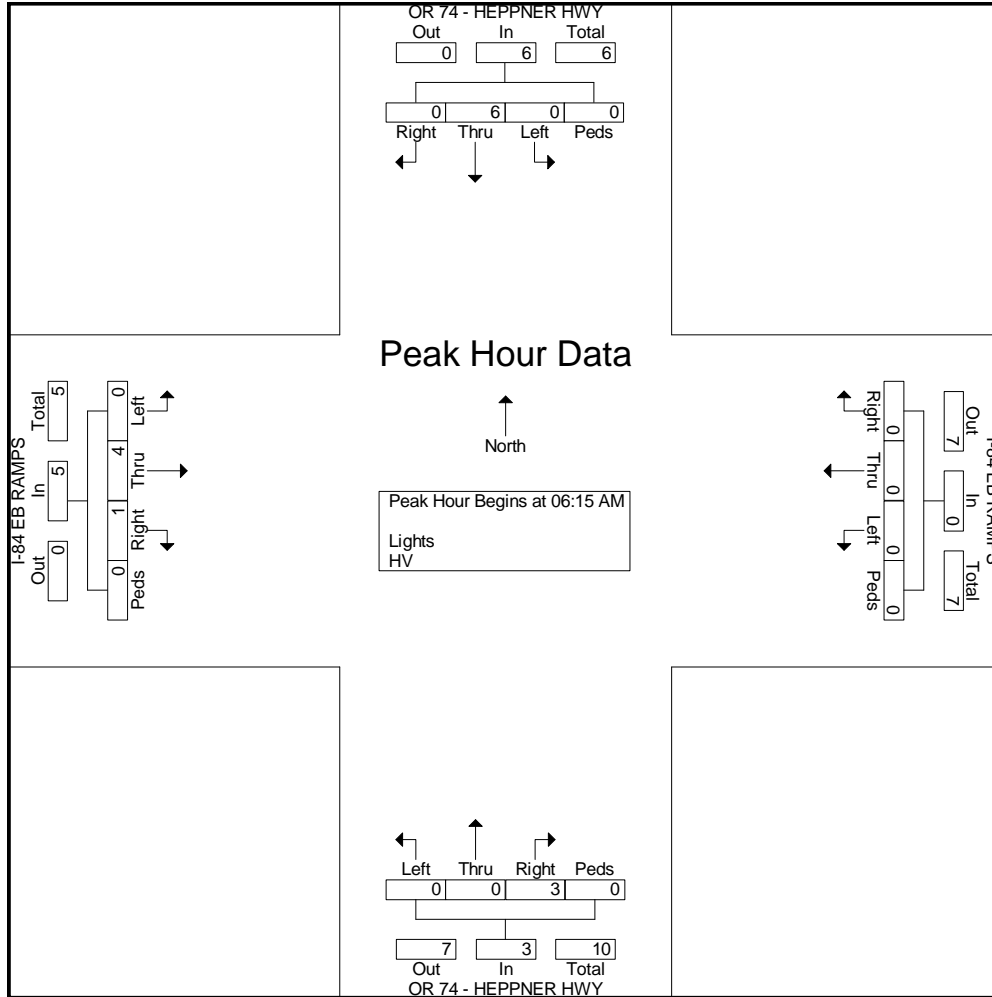

Peak Hour Analysis From 10:00 AM to 01:45 PM - Peak 1 of 1

Peak Hour for Entire Intersection Begins at 01:00 PM

01:00 PM	0	2	1	0	3	0	0	0	0	0	0	1	0	0	0	1	0	0	0	1	5
01:15 PM	0	2	0	0	2	0	0	0	0	0	0	0	0	0	0	2	0	1	0	3	5
01:30 PM	0	0	0	0	0	0	0	0	0	0	0	0	2	0	0	2	0	2	0	2	4
01:45 PM	0	0	0	0	0	0	0	0	0	0	0	2	0	0	0	2	1	1	0	0	4
Total Volume	0	4	1	0	5	0	0	0	0	0	2	3	0	0	5	3	4	1	0	8	18
% App. Total	0	80	20	0		0	0	0	0		40	60	0	0		37.5	50	12.5	0		
PHF	.000	.500	.250	.000	.417	.000	.000	.000	.000	.000	.250	.375	.000	.000	.625	.375	.500	.250	.000	.667	.900

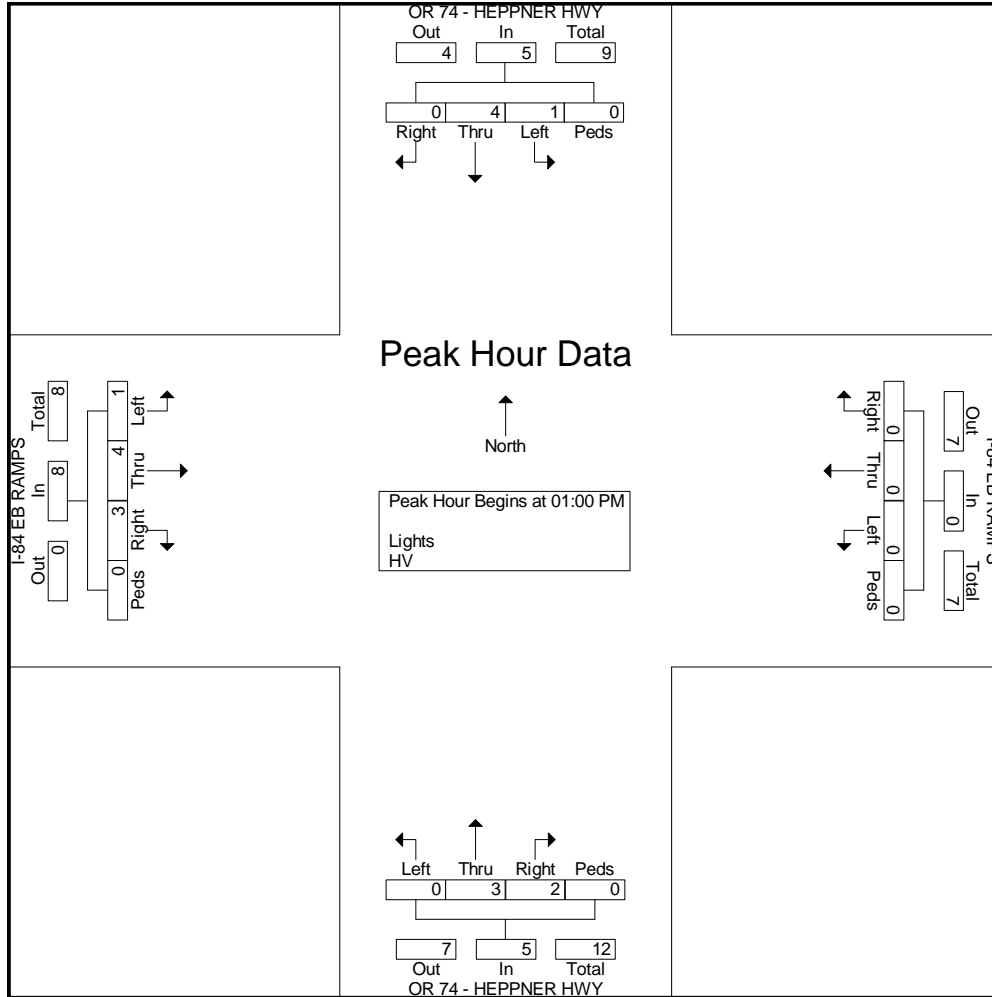

Peak Hour Analysis From 02:00 PM to 08:45 PM - Peak 1 of 1

Peak Hour for Entire Intersection Begins at 02:00 PM

02:00 PM	0	2	0	0	2	0	0	0	0	0	1	3	0	0	4	0	0	0	0	6
02:15 PM	0	1	0	0	1	0	0	0	0	0	1	0	0	0	1	1	0	0	0	3
02:30 PM	0	1	0	0	1	0	0	0	0	0	2	0	0	0	2	1	0	0	0	4
02:45 PM	0	1	0	0	1	0	0	0	0	0	3	1	0	0	4	1	0	0	0	6
Total Volume	0	5	0	0	5	0	0	0	0	0	7	4	0	0	11	3	0	0	0	19
% App. Total	0	100	0	0	0	0	0	0	0	0	63.6	36.4	0	0	0	100	0	0	0	0
PHF	.000	.625	.000	.000	.625	.000	.000	.000	.000	.000	.583	.333	.000	.000	.688	.750	.000	.000	.000	.750

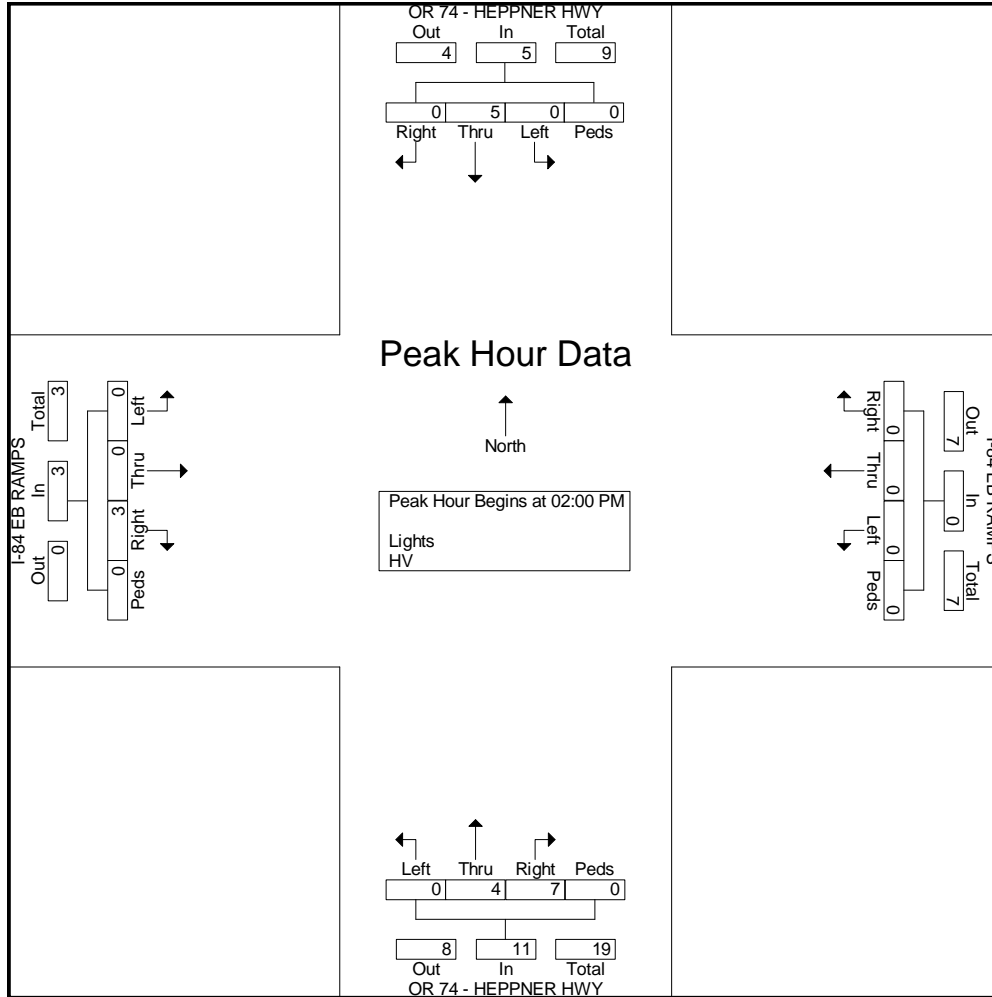

Groups Printed- Lights - HV

Start Time	OR 19 - JOHN DAY HWY Southbound				CEDAR SPRINGS LN Westbound				OR 19 - JOHN DAY HWY Northbound				CEDAR SPRINGS LN Eastbound				Int. Total
	Right	Thru	Left	Peds	Right	Thru	Left	Peds	Right	Thru	Left	Peds	Right	Thru	Left	Peds	
05:00 AM	2	1	0	0	0	0	0	0	0	0	2	0	0	0	1	0	6
05:15 AM	10	0	0	0	0	0	0	0	0	0	3	0	1	0	2	0	16
05:30 AM	18	0	0	0	0	0	0	0	0	1	5	0	1	0	1	0	26
05:45 AM	10	2	0	0	0	0	0	0	0	2	2	0	0	0	4	0	20
Total	40	3	0	0	0	0	0	0	0	3	12	0	2	0	8	0	68
06:00 AM	3	1	0	0	0	0	0	0	0	0	0	0	2	0	3	0	9
06:15 AM	2	0	0	0	0	0	0	0	0	1	1	0	0	0	3	0	7
06:30 AM	5	1	0	0	0	0	0	0	0	2	1	0	0	0	1	0	10
06:45 AM	5	0	0	0	0	0	0	0	0	2	0	0	1	0	0	0	8
Total	15	2	0	0	0	0	0	0	0	5	2	0	3	0	7	0	34
07:00 AM	3	1	0	1	0	0	0	0	0	2	0	0	0	0	3	0	10
07:15 AM	6	1	0	0	0	0	0	0	0	3	0	0	0	0	6	0	16
07:30 AM	4	0	0	0	0	0	0	0	0	3	1	0	0	0	2	0	10
07:45 AM	3	3	0	0	0	0	0	0	0	1	2	0	0	0	2	0	11
Total	16	5	0	1	0	0	0	0	0	9	3	0	0	0	13	0	47
08:00 AM	1	1	0	0	0	0	0	0	0	0	0	0	0	0	6	0	8
08:15 AM	4	3	0	0	0	0	0	0	0	3	0	0	1	0	1	0	12
08:30 AM	2	2	0	0	0	0	0	0	0	3	1	0	3	0	4	0	15
08:45 AM	5	0	0	0	0	0	0	0	0	1	0	0	0	0	2	0	8
Total	12	6	0	0	0	0	0	0	0	7	1	0	4	0	13	0	43
09:00 AM	5	0	0	0	0	0	0	0	0	4	0	0	1	0	2	0	12
09:15 AM	4	1	0	0	0	0	0	0	0	2	0	0	0	0	1	0	8
09:30 AM	3	5	0	0	0	0	0	0	0	0	0	0	0	0	5	0	13
09:45 AM	12	2	0	0	0	0	0	0	0	5	0	0	0	0	3	0	22
Total	24	8	0	0	0	0	0	0	0	11	0	0	1	0	11	0	55
10:00 AM	5	2	0	0	0	0	0	0	0	2	1	0	0	0	3	0	13
10:15 AM	5	2	0	0	0	0	0	0	0	1	0	0	0	0	4	0	12
10:30 AM	3	6	0	0	0	0	0	0	0	5	0	0	2	0	4	0	20
10:45 AM	0	0	0	0	0	0	0	0	0	0	0	0	1	0	2	0	3
Total	13	10	0	0	0	0	0	0	0	8	1	0	3	0	13	0	48
11:00 AM	1	2	0	0	0	0	0	0	0	0	1	0	0	0	2	0	6
11:15 AM	4	0	0	0	0	0	0	0	0	1	0	0	0	0	0	0	5
11:30 AM	2	1	0	0	0	0	0	0	0	0	0	0	0	0	2	0	5
11:45 AM	0	0	0	0	0	0	0	0	0	0	0	0	0	0	0	0	0
Total	7	3	0	0	0	0	0	0	0	1	1	0	0	0	4	0	16
12:00 PM	5	1	0	1	0	0	0	0	0	1	0	0	0	0	4	0	12
12:15 PM	4	3	0	0	0	0	0	0	0	1	1	0	1	0	6	0	16
12:30 PM	1	1	0	0	0	0	0	0	0	0	0	0	0	0	4	0	6
12:45 PM	1	1	0	0	0	0	0	0	0	0	0	0	0	0	3	0	5
Total	11	6	0	1	0	0	0	0	0	2	1	0	1	0	17	0	39
01:00 PM	5	1	0	1	0	0	0	0	0	0	0	0	0	0	4	0	11
01:15 PM	1	3	0	0	0	0	0	0	0	1	0	0	0	0	2	0	7
01:30 PM	0	2	0	0	0	0	0	0	0	4	0	0	1	0	4	0	11
01:45 PM	5	2	0	0	0	0	0	0	0	0	0	0	0	0	2	0	9
Total	11	8	0	1	0	0	0	0	0	5	0	0	1	0	12	0	38

Groups Printed- Lights - HV

Start Time	OR 19 - JOHN DAY HWY Southbound				CEDAR SPRINGS LN Westbound				OR 19 - JOHN DAY HWY Northbound				CEDAR SPRINGS LN Eastbound				Int. Total
	Right	Thru	Left	Peds	Right	Thru	Left	Peds	Right	Thru	Left	Peds	Right	Thru	Left	Peds	
02:00 PM	2	1	0	1	0	0	0	0	0	0	0	0	0	0	1	0	5
02:15 PM	0	2	0	0	0	0	0	0	0	4	2	0	0	0	2	0	10
02:30 PM	2	4	0	0	0	0	0	0	0	0	0	0	2	0	7	0	15
02:45 PM	6	2	0	0	0	0	0	0	0	1	0	0	1	0	1	0	11
Total	10	9	0	1	0	0	0	0	0	5	2	0	3	0	11	0	41
03:00 PM	2	1	0	1	0	0	0	0	0	0	0	0	0	0	5	0	9
03:15 PM	0	2	0	0	0	0	0	0	0	1	1	0	1	0	0	0	5
03:30 PM	2	2	0	0	0	0	0	0	0	2	0	0	1	0	1	0	8
03:45 PM	1	4	0	0	0	0	0	0	0	3	0	0	3	0	8	0	19
Total	5	9	0	1	0	0	0	0	0	6	1	0	5	0	14	0	41
04:00 PM	4	1	0	0	0	0	0	0	0	1	1	0	0	0	7	0	14
04:15 PM	1	5	0	0	0	0	0	0	0	0	0	0	2	0	12	0	20
04:30 PM	1	3	0	0	0	0	0	0	0	3	0	0	0	0	13	0	20
04:45 PM	0	0	0	0	0	0	0	0	0	0	0	0	0	0	0	0	0
Total	6	9	0	0	0	0	0	0	0	4	1	0	2	0	32	0	54
05:00 PM	3	2	0	0	0	0	0	0	0	3	1	0	0	0	3	0	12
05:15 PM	2	3	0	0	0	0	0	0	0	2	0	0	1	0	5	0	13
05:30 PM	2	1	0	0	0	0	0	0	0	2	1	0	2	0	7	0	15
05:45 PM	0	0	0	0	0	0	0	0	0	0	0	0	0	0	0	0	0
Total	7	6	0	0	0	0	0	0	0	7	2	0	3	0	15	0	40
06:00 PM	3	1	0	0	0	0	0	0	0	0	0	1	0	0	4	0	9
06:15 PM	2	1	0	0	0	0	0	0	0	1	1	0	0	0	3	0	8
06:30 PM	6	3	0	0	0	0	0	0	0	0	1	0	3	0	0	0	13
06:45 PM	2	0	0	0	0	0	0	0	0	0	0	0	0	0	1	0	3
Total	13	5	0	0	0	0	0	0	0	1	2	1	3	0	8	0	33
07:00 PM	0	0	0	0	0	0	0	0	0	0	0	1	0	0	4	0	5
07:15 PM	2	1	0	0	0	0	0	0	0	1	0	0	0	0	1	0	5
07:30 PM	0	0	0	0	0	0	0	0	0	1	0	0	0	0	2	0	3
07:45 PM	0	2	0	0	0	0	0	0	0	2	0	0	0	0	0	0	4
Total	2	3	0	0	0	0	0	0	0	4	0	1	0	0	7	0	17
08:00 PM	0	1	0	0	0	0	0	0	0	0	0	0	0	0	1	0	2
08:15 PM	0	2	0	0	0	0	0	0	0	0	0	0	0	0	0	0	2
08:30 PM	0	1	0	0	0	0	0	0	0	0	0	0	0	0	0	0	1
08:45 PM	1	0	0	0	0	0	0	0	0	2	0	0	0	0	0	0	3
Total	1	4	0	0	0	0	0	0	0	2	0	0	0	0	1	0	8
Grand Total	193	96	0	5	0	0	0	0	0	80	29	2	31	0	186	0	622
Apprch %	65.6	32.7	0	1.7	0	0	0	0	0	72.1	26.1	1.8	14.3	0	85.7	0	
Total %	31	15.4	0	0.8	0	0	0	0	0	12.9	4.7	0.3	5	0	29.9	0	
Lights	122	90	0	5	0	0	0	0	0	72	27	2	30	0	103	0	451
% Lights	63.2	93.8	0	100	0	0	0	0	0	90	93.1	100	96.8	0	55.4	0	72.5
HV	71	6	0	0	0	0	0	0	0	8	2	0	1	0	83	0	171
% HV	36.8	6.2	0	0	0	0	0	0	0	10	6.9	0	3.2	0	44.6	0	27.5

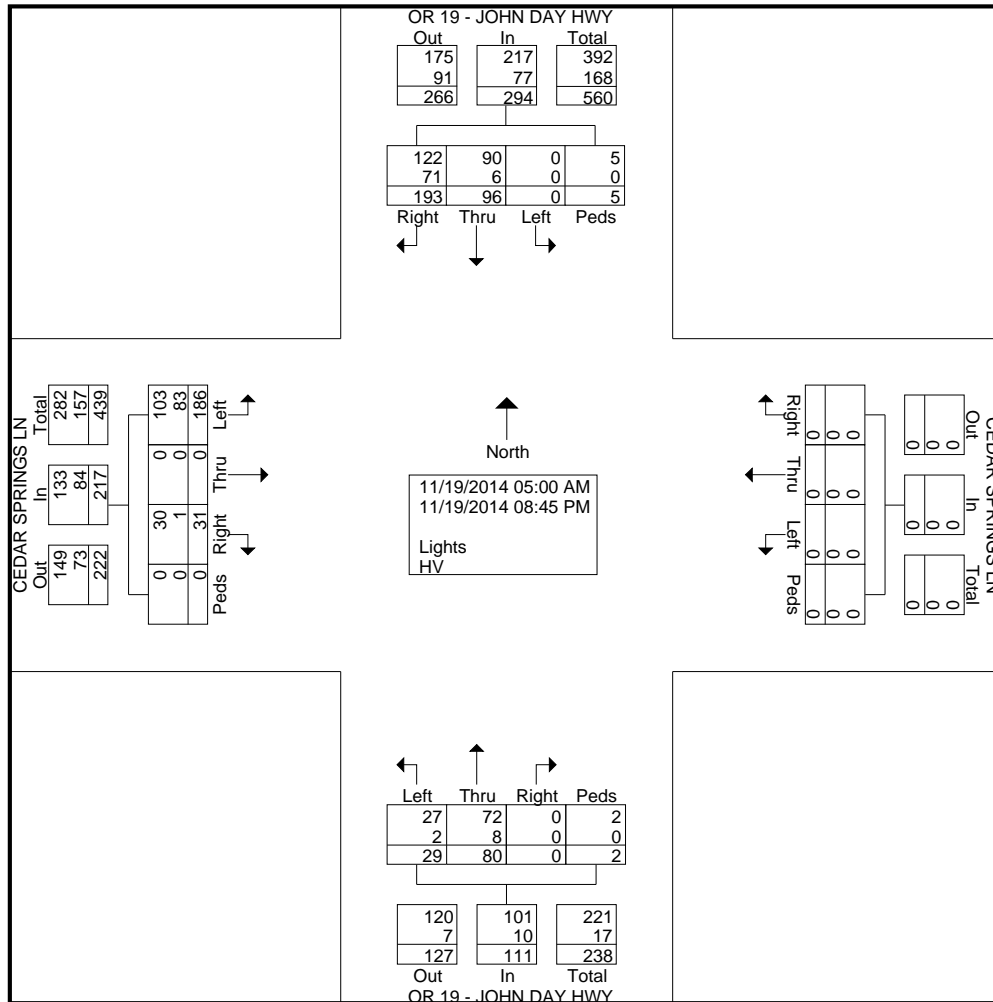

Start Time	OR 19 - JOHN DAY HWY Southbound					CEDAR SPRINGS LN Westbound					OR 19 - JOHN DAY HWY Northbound					CEDAR SPRINGS LN Eastbound					Int. Total
	Right	Thru	Left	Peds	App. Total	Right	Thru	Left	Peds	App. Total	Right	Thru	Left	Peds	App. Total	Right	Thru	Left	Peds	App. Total	
Peak Hour Analysis From 05:00 AM to 09:45 AM - Peak 1 of 1																					
Peak Hour for Entire Intersection Begins at 05:15 AM																					
05:15 AM	10	0	0	0	10	0	0	0	0	0	0	0	3	0	3	1	0	2	0	3	16
05:30 AM	18	0	0	0	18	0	0	0	0	0	0	1	5	0	6	1	0	1	0	2	26
05:45 AM	10	2	0	0	12	0	0	0	0	0	0	2	2	0	4	0	0	4	0	4	20
06:00 AM	3	1	0	0	4	0	0	0	0	0	0	0	0	0	0	2	0	3	0	5	9
Total Volume	41	3	0	0	44	0	0	0	0	0	0	3	10	0	13	4	0	10	0	14	71
% App. Total	93.2	6.8	0	0		0	0	0	0		0	23.1	76.9	0		28.6	0	71.4	0		
PHF	.569	.375	.000	.000	.611	.000	.000	.000	.000	.000	.000	.375	.500	.000	.542	.500	.000	.625	.000	.700	.683

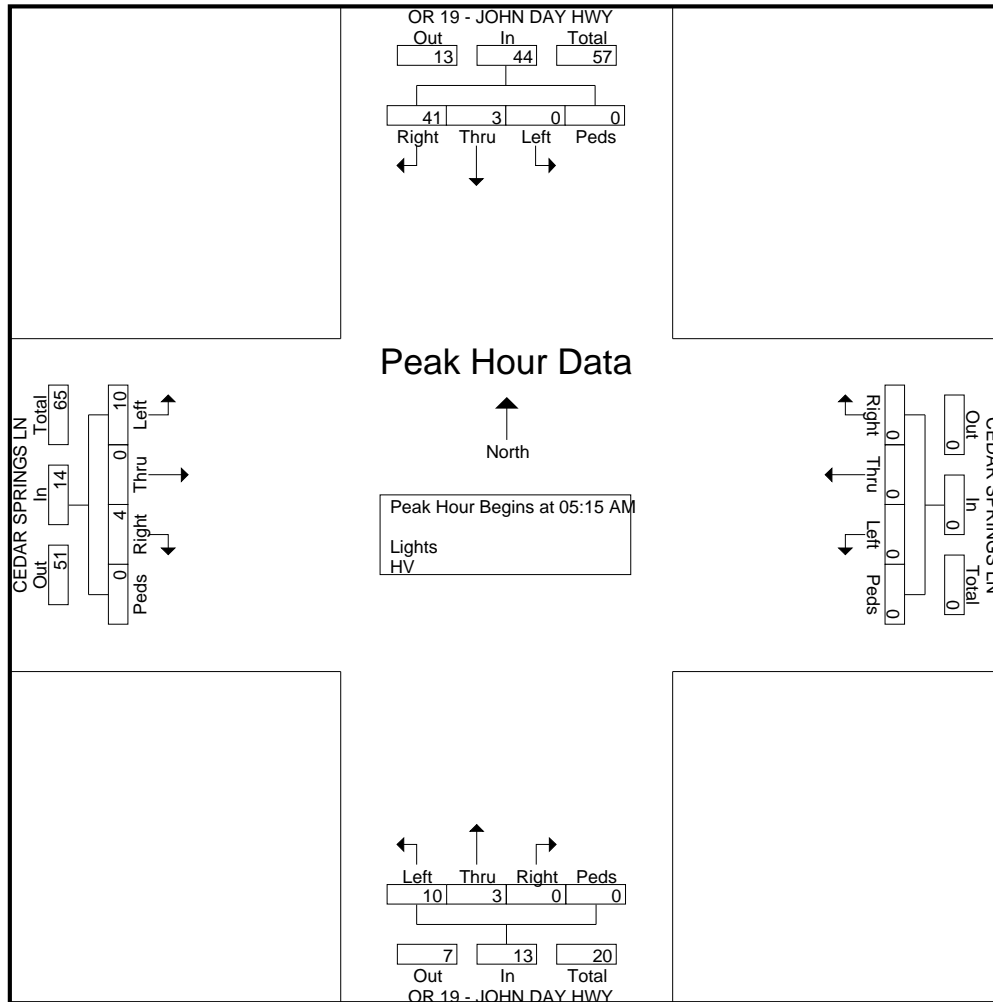

Peak Hour Analysis From 10:00 AM to 01:45 PM - Peak 1 of 1

Peak Hour for Entire Intersection Begins at 10:00 AM

10:00 AM	5	2	0	0	7	0	0	0	0	0	0	2	1	0	3	0	0	3	0	3	13
10:15 AM	5	2	0	0	7	0	0	0	0	0	0	1	0	0	1	0	0	4	0	4	12
10:30 AM	3	6	0	0	9	0	0	0	0	0	0	5	0	0	5	2	0	4	0	6	20
10:45 AM	0	0	0	0	0	0	0	0	0	0	0	0	0	0	0	1	0	2	0	3	3
Total Volume	13	10	0	0	23	0	0	0	0	0	0	8	1	0	9	3	0	13	0	16	48
% App. Total	56.5	43.5	0	0		0	0	0	0	0	0	88.9	11.1	0		18.8	0	81.2	0		
PHF	.650	.417	.000	.000	.639	.000	.000	.000	.000	.000	.000	.400	.250	.000	.450	.375	.000	.813	.000	.667	.600

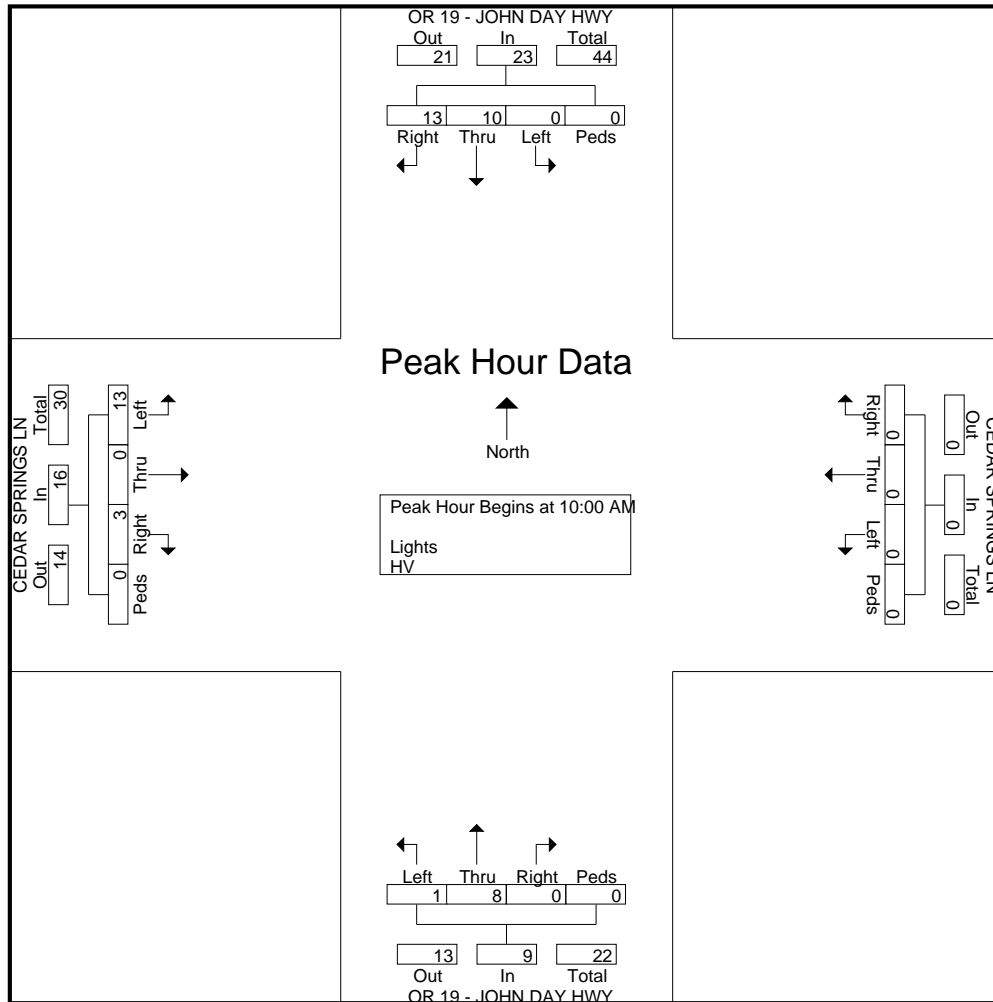

Peak Hour Analysis From 02:00 PM to 08:45 PM - Peak 1 of 1
Peak Hour for Entire Intersection Begins at 03:45 PM

03:45 PM	1	4	0	0	5	0	0	0	0	0	0	3	0	0	3	3	0	8	0	11	19
04:00 PM	4	1	0	0	5	0	0	0	0	0	0	1	1	0	2	0	0	7	0	7	14
04:15 PM	1	5	0	0	6	0	0	0	0	0	0	0	0	0	0	2	0	12	0	14	20
04:30 PM	1	3	0	0	4	0	0	0	0	0	0	3	0	0	3	0	0	13	0	13	20
Total Volume	7	13	0	0	20	0	0	0	0	0	0	7	1	0	8	5	0	40	0	45	73
% App. Total	35	65	0	0		0	0	0	0		0	87.5	12.5	0		11.1	0	88.9	0		
PHF	.438	.650	.000	.000	.833	.000	.000	.000	.000	.000	.000	.583	.250	.000	.667	.417	.000	.769	.000	.804	.913

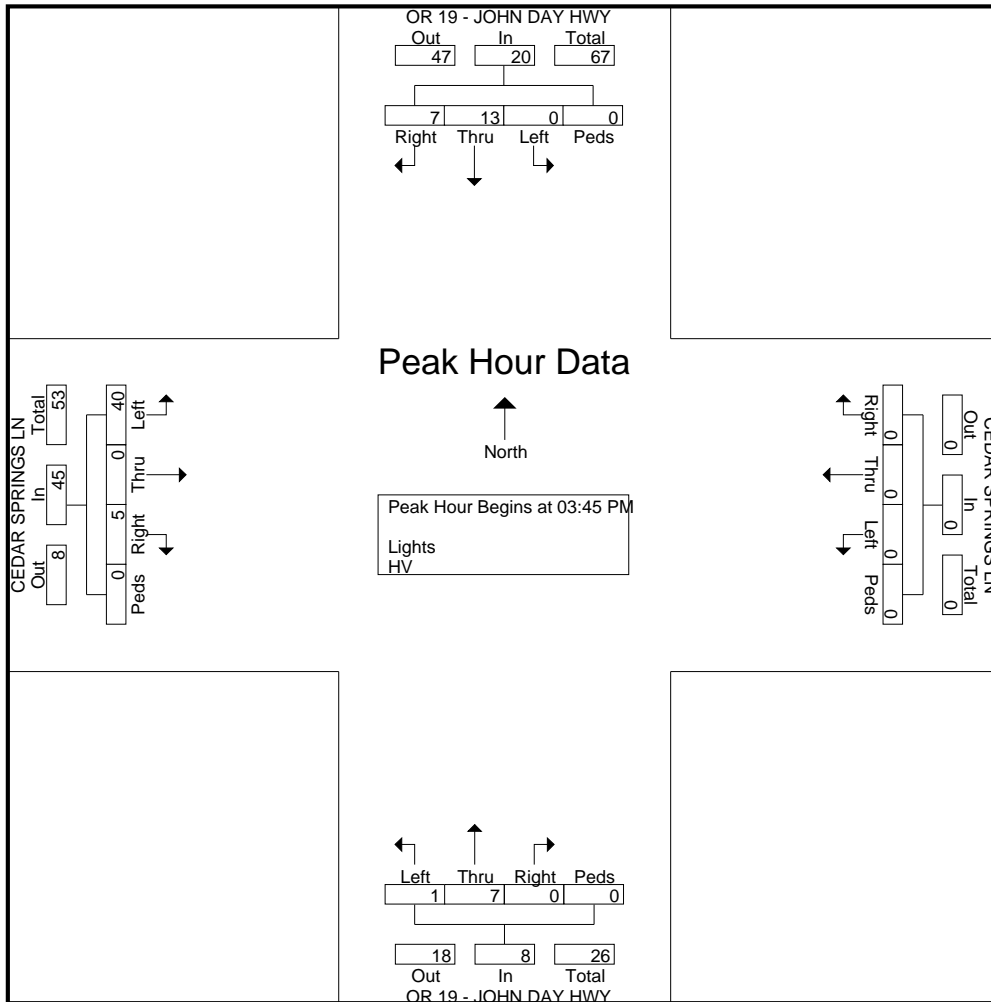

DRAFT

Appendix 3 Methodology Memorandum

DRAFT

Appendix 4 Roadway Segment Traffic
Volume Profiles

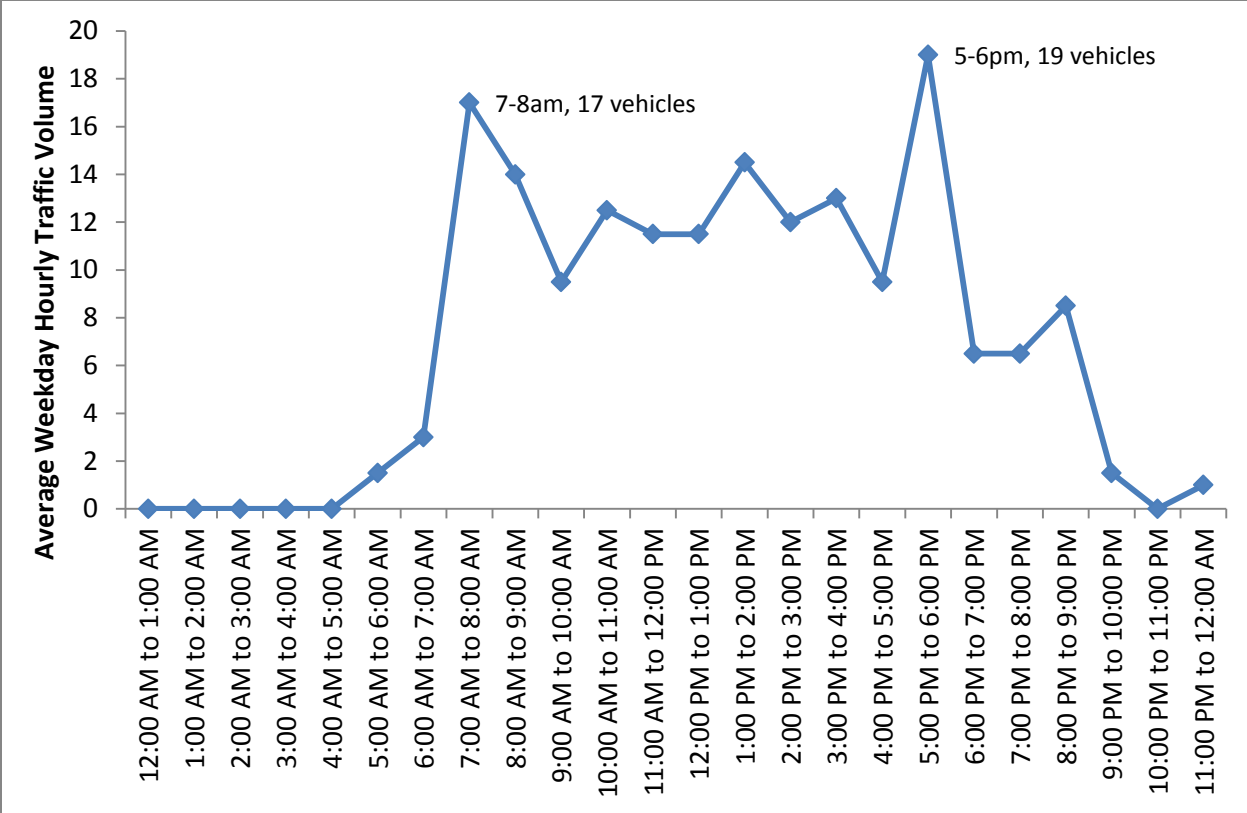

Figure 4-1. Lonerock Road (south of OR 19) Average Weekday Hourly Traffic Profile (Both Directions)

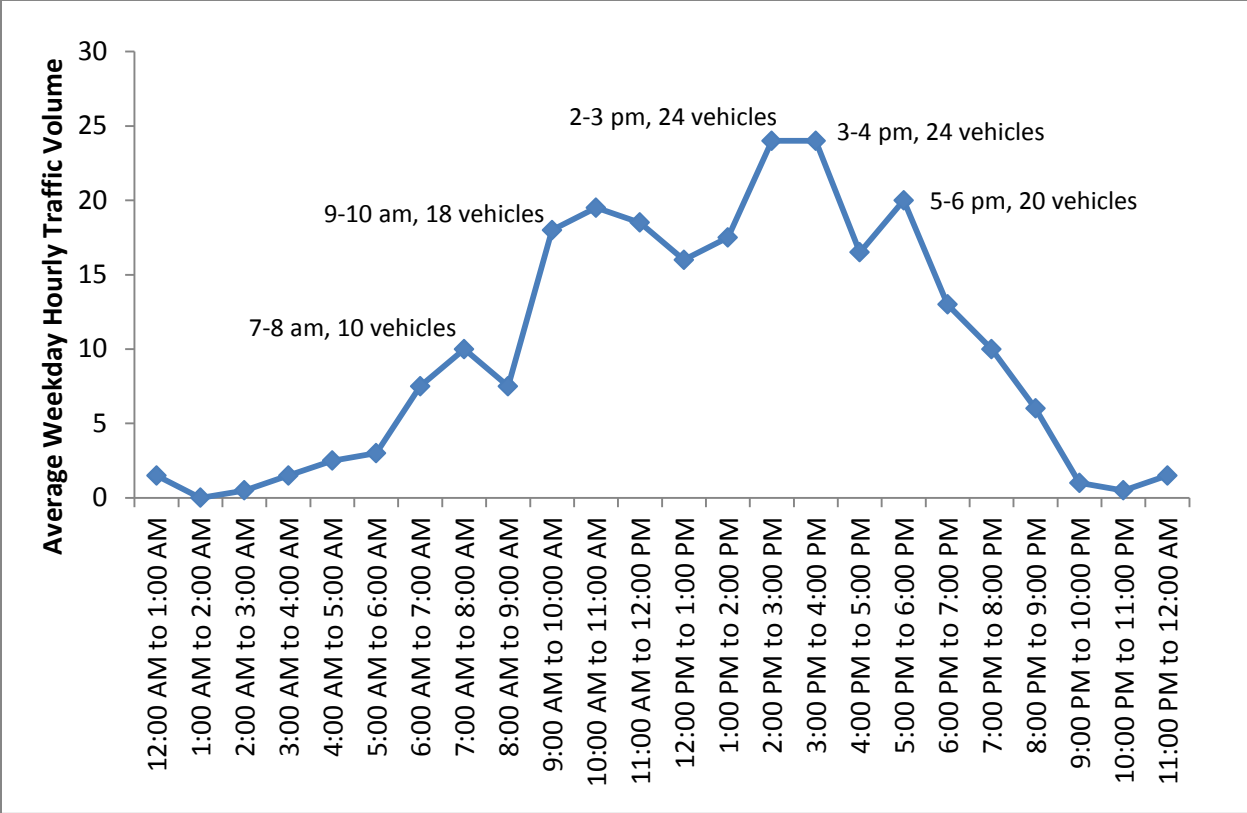

Figure 4-2. Baseline Road (East of OR 19) Average Weekday Hourly Traffic Profile (Both Directions)

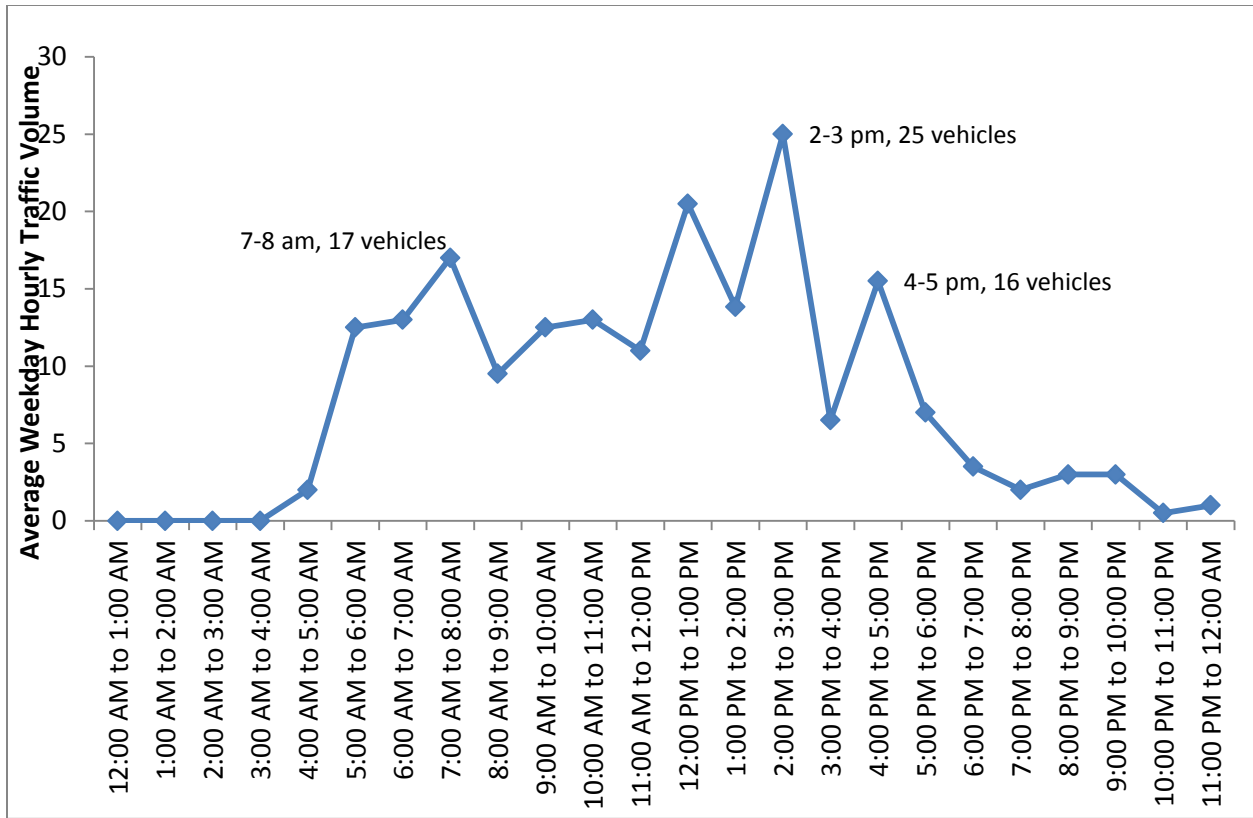

Figure 4-3. Fourmile Road (SE of OR 19) Average Weekday Hourly Traffic Profile (Both Directions)

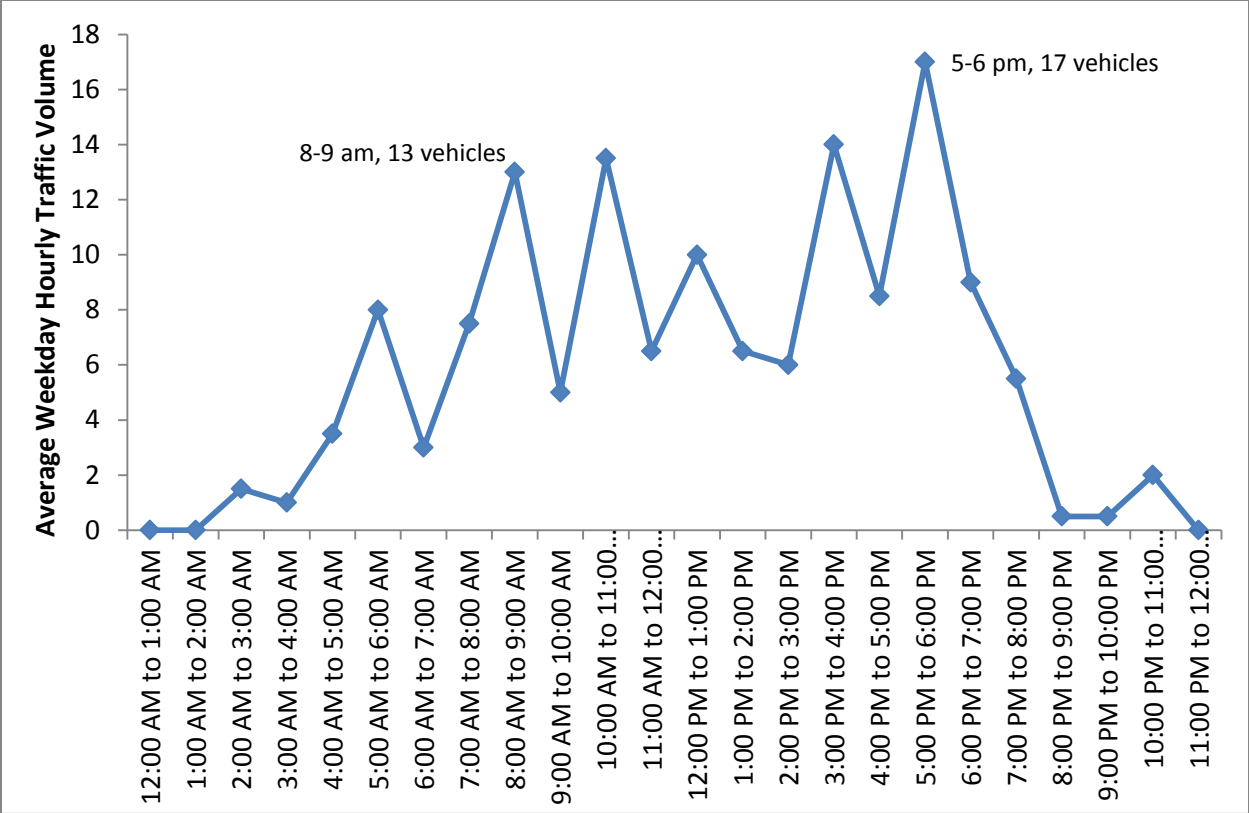

Figure 4-4. Blalock Canyon Road (South of I-84) Average Weekday Hourly Traffic Profile (Both Directions)

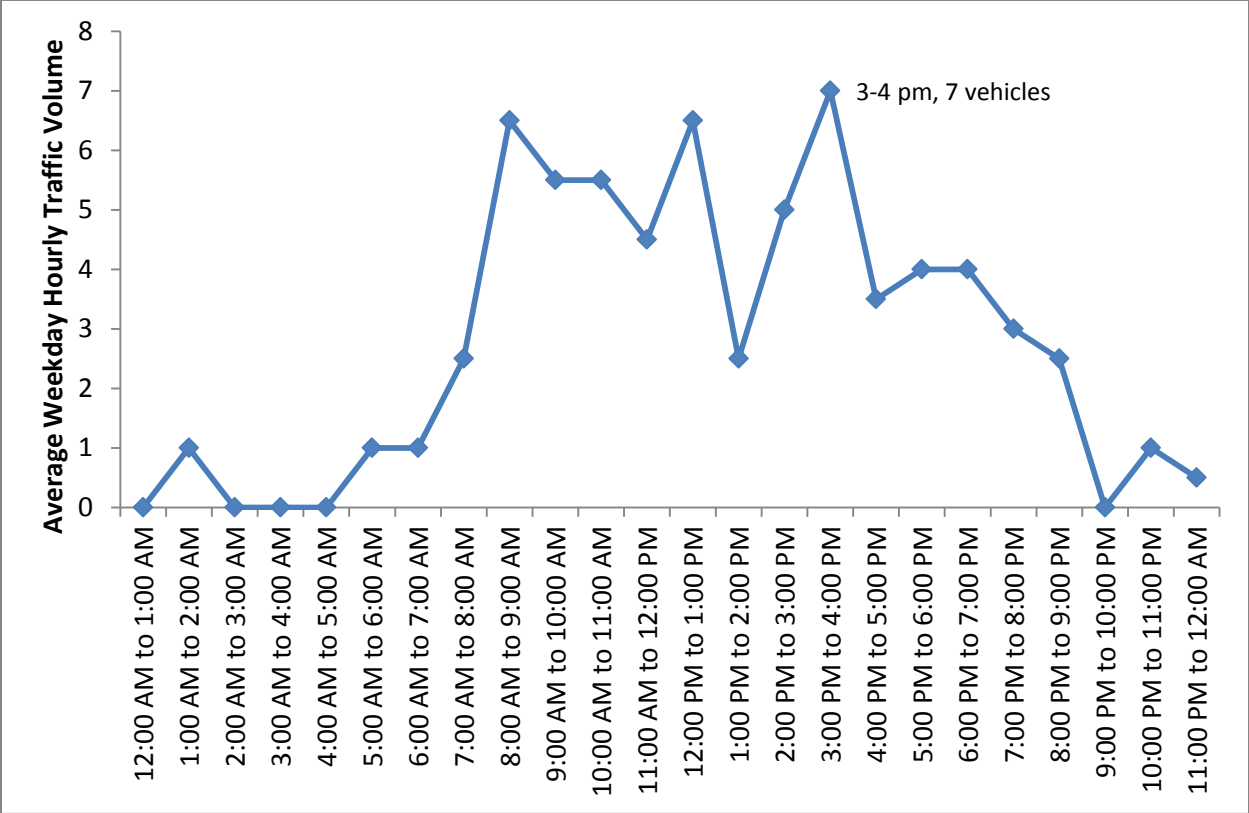

Figure 4-5. Quinton Canyon Road (South of I-84) Average Weekday Hourly Traffic Profile (Both Directions)

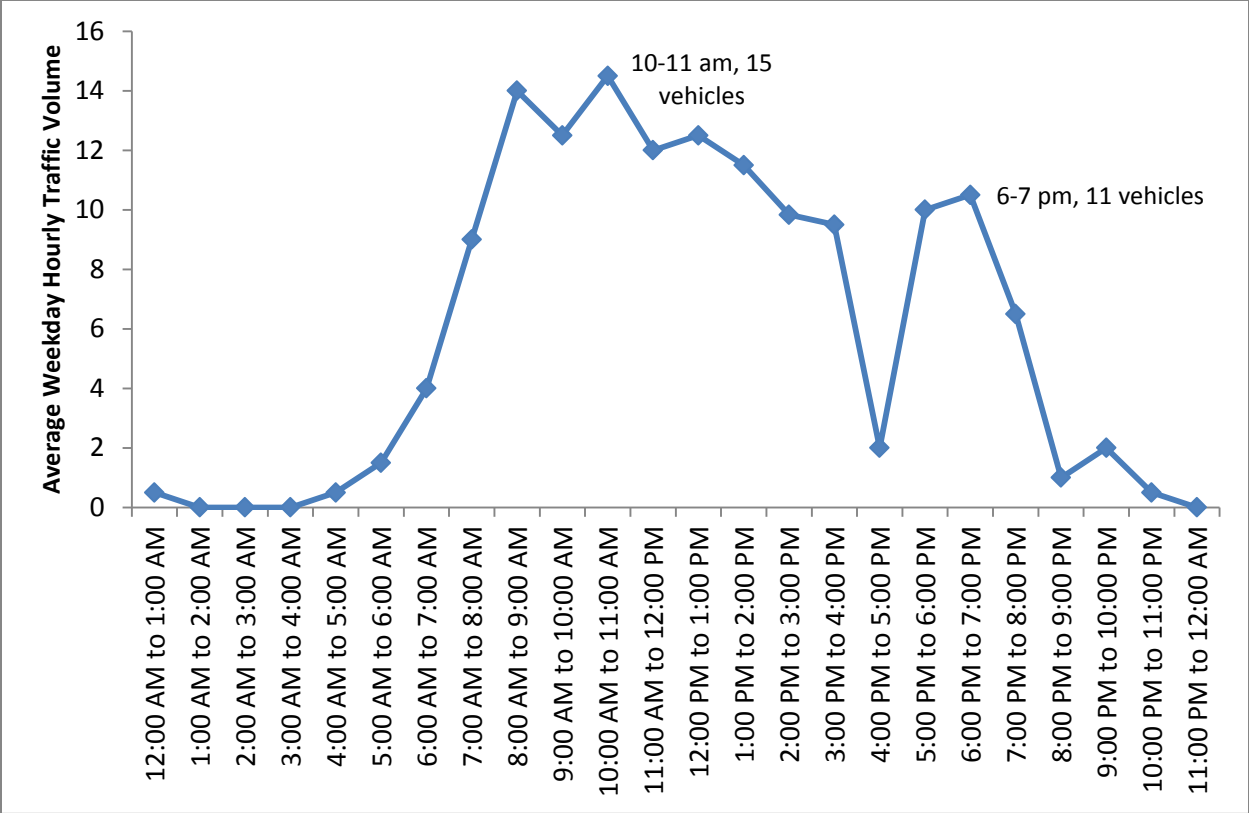

Figure 4-6. Mikkalo Lane (West of OR 19) Average Weekday Hourly Traffic Profile (Both Directions)

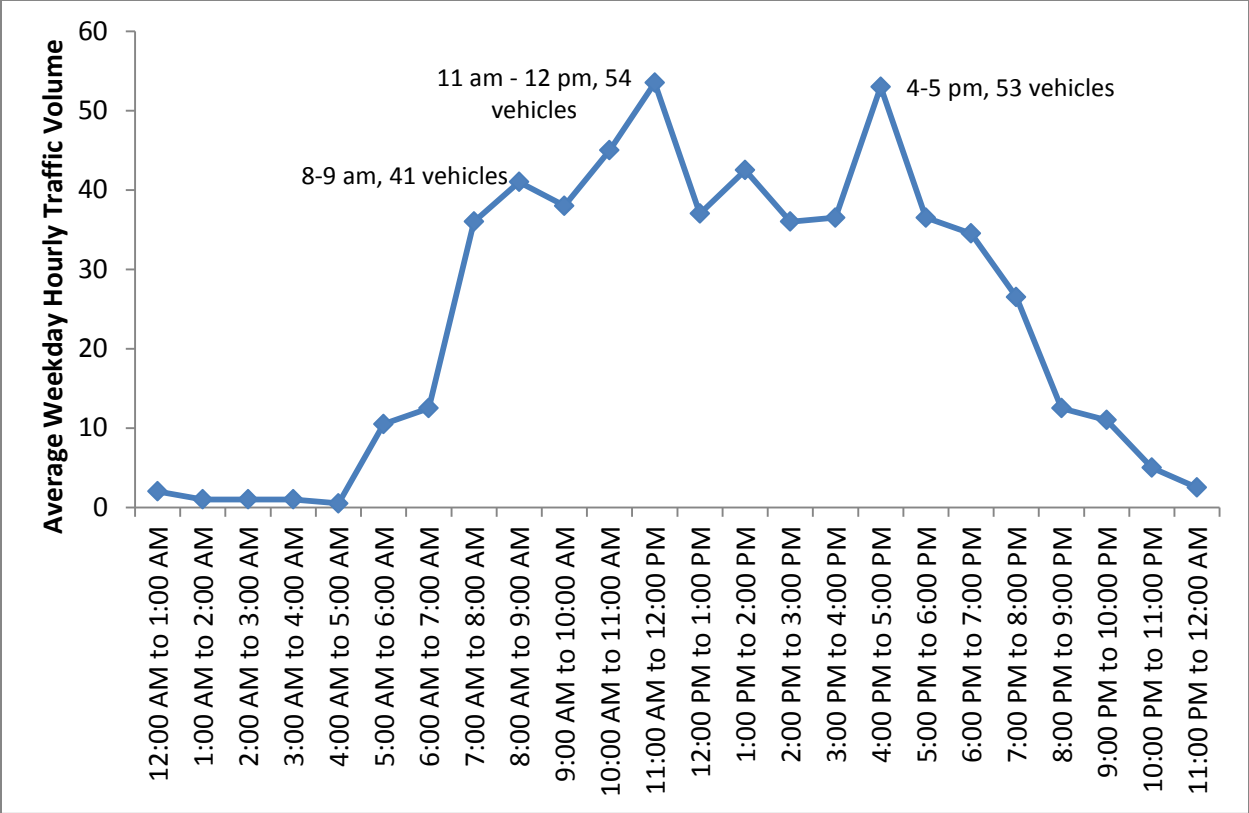

Figure 4-7. E Bayard Street (at Condon High School) Average Weekday Hourly Traffic Profile (Both Directions)

DRAFT

Appendix 5 Existing Conditions Traffic
Operations Analysis
Worksheets & Queue Length
Calculations

MOVEMENT SUMMARY

 Site: Main St/E Walnut St

Gilliam County
Stop (Two-Way)

Movement Performance - Vehicles											
Mov ID	OD Mov	Demand Flows		Deg. Satn	Average Delay	Level of Service	95% Back of Queue		Prop. Queued	Effective Stop Rate	Average Speed
		Total	HV		sec		Vehicles	Distance		per veh	mph
		veh/h	%	v/c			veh	ft			
South: S Main Street											
3	L2	30	4.0	0.086	1.2	LOS A	0.3	8.9	0.25	0.12	33.2
8	T1	46	2.0	0.086	1.2	LOS A	0.3	8.9	0.25	0.12	33.4
18	R2	35	6.0	0.023	0.0	LOS A	0.0	0.0	0.00	0.00	34.7
Approach		111	3.8	0.086	0.8	LOS A	0.3	8.9	0.17	0.08	33.7
East: E Walnut Street											
1	L2	32	10.0	0.038	0.0	LOS A	0.0	0.0	0.00	0.00	35.4
6	T1	18	1.0	0.038	0.0	LOS A	0.0	0.0	0.00	0.00	37.2
16	R2	15	4.0	0.038	0.0	LOS A	0.0	0.0	0.00	0.00	35.7
Approach		65	6.1	0.038	0.0	NA	0.0	0.0	0.00	0.00	36.0
North: N Main Street											
7	L2	5	3.0	0.044	0.8	LOS A	0.2	4.2	0.15	0.07	33.3
4	T1	27	4.0	0.044	0.8	LOS A	0.2	4.2	0.15	0.07	33.3
14	R2	6	19.0	0.044	0.8	LOS A	0.2	4.2	0.15	0.07	32.9
Approach		38	6.4	0.044	0.8	LOS A	0.2	4.2	0.15	0.07	33.3
West: W Walnut Street											
5	L2	6	26.0	0.089	9.5	LOS A	0.4	9.3	0.21	0.10	28.7
2	T1	35	8.0	0.089	9.5	LOS A	0.4	9.3	0.21	0.10	29.4
12	R2	37	2.0	0.089	9.5	LOS A	0.4	9.3	0.21	0.10	29.6
Approach		78	6.6	0.089	9.5	LOS A	0.4	9.3	0.21	0.10	29.4
All Vehicles		292	5.4	0.089	2.9	NA	0.4	9.3	0.14	0.07	32.8

Level of Service (LOS) Method: Delay & v/c (HCM 2010).

Vehicle movement LOS values are based on average delay and v/c ratio (degree of saturation) per movement

LOS F will result if v/c > 1 irrespective of movement delay value (does not apply for approaches and intersection).

Minor Road Approach LOS values are based on average delay for all movements (v/c not used as specified in HCM 2010).

NA: Intersection LOS and Major Road Approach LOS values are Not Applicable for two-way sign control since the average delay is not a good LOS measure due to zero delays associated with major road movements.

HCM Delay Formula option is used. Control Delay does not include Geometric Delay since Exclude Geometric Delay option applies.

Gap-Acceptance Capacity: Traditional M1.

HV (%) values are calculated for All Movement Classes of All Heavy Vehicle Model Designation.

Gilliam County TSP

Vistro File: H:\...\existing conditions.vistro

Scenario: Base Scenario

Report File: H:\...\existingconditions_report.pdf

11/25/2014

Intersection Analysis Summary

ID	Intersection Name	Control Type	Method	Worst Mvmt	V/C	Delay (s/veh)	LOS
2	Main Street/E Bayard Street	Two-way stop	HCM2010	EBL	0.026	4.2	A
3	Cottonwood Street / Beech Street	Two-way stop	HCM2010	SBT	0.018	4.8	A
4	I-84 Ramps / Beech Street	Two-way stop	HCM2010	EBT	0.001	3.0	A
5	OR 74 / I-84 Eastbound Ramps	Two-way stop	HCM2010	WBL	0.000	2.1	A
6	OR 19 / Cedar Springs Lane	Two-way stop	HCM2010	EBL	0.058	5.9	A

V/C, Delay, LOS: For two-way stop, these values are taken from the movement with the worst (highest) delay value; for all other control types, they are taken for the whole intersection.

**Intersection Level Of Service Report
#2: Main Street/E Bayard Street**

Control Type: Two-way stop
Analysis Method: HCM2010
Analysis Period: 15 minutes

Delay (sec / veh): 4.2
Level Of Service: A
Volume to Capacity (v/c): 0.026

Intersection Setup

Name	Main Street			Main Street			E Bayard Street			Access		
Approach	Northbound			Southbound			Eastbound			Westbound		
Lane Configuration	+			+			+			+		
Turning Movement	Left	Thru	Right	Left	Thru	Right	Left	Thru	Right	Left	Thru	Right
Lane Width	12.00	12.00	12.00	12.00	12.00	12.00	12.00	12.00	12.00	12.00	12.00	12.00
No. of Lanes in Pocket	0	0	0	0	0	0	0	0	0	0	0	0
Pocket Length	100.00/1	100.00/1	100.00/1	100.00/1	100.00/1	100.00/1	100.00/1	100.00/1	100.00/1	100.00/1	100.00/1	100.00/1
Speed	25.00			25.00			30.00			30.00		
Grade	0.00			0.00			0.00			0.00		
Crosswalk	no			no			no			no		

Volumes

Name	Main Street			Main Street			E Bayard Street			Access		
Base Volume Input [veh/h]	2	26	5	23	26	11	16	1	3	1	1	19
Base Volume Adjustment Factor	1.0000/1	1.0000/1	1.0000/1	1.0000/1	1.0000/1	1.0000/1	1.0000/1	1.0000/1	1.0000/1	1.0000/1	1.0000/1	1.0000/1
Heavy Vehicles Percentage [%]	6			7			12			5		
Growth Rate	1.00	1.00	1.00	1.00	1.00	1.00	1.00	1.00	1.00	1.00	1.00	1.00
In-Process Volume [veh/h]	0	0	0	0	0	0	0	0	0	0	0	0
Site-Generated Trips [veh/h]	0	0	0	0	0	0	0	0	0	0	0	0
Diverted Trips [veh/h]	0	0	0	0	0	0	0	0	0	0	0	0
Pass-by Trips [veh/h]	0	0	0	0	0	0	0	0	0	0	0	0
Existing Site Adjustment Volume [veh/h]	0	0	0	0	0	0	0	0	0	0	0	0
Other Volume [veh/h]	0	0	0	0	0	0	0	0	0	0	0	0
Right-Turn on Red Volume [veh/h]	0	0	0	0	0	0	0	0	0	0	0	0
Total Hourly Volume [veh/h]	2	26	5	23	26	11	16	1	3	1	1	19
Peak Hour Factor	0.8000/0	0.8000/0	0.8000/0	0.8000/0	0.8000/0	0.8000/0	0.8000/0	0.8000/0	0.8000/0	0.8000/0	0.8000/0	0.8000/0
Other Adjustment Factor	1.0000/1	1.0000/1	1.0000/1	1.0000/1	1.0000/1	1.0000/1	1.0000/1	1.0000/1	1.0000/1	1.0000/1	1.0000/1	1.0000/1
Total 15-Minute Volume [vehicles]	1	8	2	7	8	3	5	0	1	0	0	6
Total Analysis Volume [veh/h]	3	33	6	29	33	14	20	1	4	1	1	24
Pedestrian Volume [ped/h]	0			0			0			0		
Bicycle Volume [bicycles/h]	0			0			0			0		

Intersection Settings

Priority Scheme	Free	Free	Stop	Stop
-----------------	------	------	------	------

Movement, Approach, & Intersection Results

V/C, Movement V/C Ratio	0.00	0.00	0.00	0.02	0.00	0.00	0.03	0.00	0.00	0.00	0.00	0.02
d_M, Delay for Movement [s / veh]	7.35	0.00	0.00	7.38	0.00	0.00	9.71	9.71	9.71	8.69	8.69	8.69
Movement LOS	A	A	A	A	A	A	A	A	A	A	A	A
d_A, Approach Delay [s / veh]	0.52			2.82			9.71			8.69		
Approach LOS	A			A			A			A		
d_I, Intersection Delay [s / veh]	4.17											
Intersection LOS	A											

**Intersection Level Of Service Report
#3: Cottonwood Street / Beech Street**

Control Type: Two-way stop
Analysis Method: HCM2010
Analysis Period: 15 minutes

Delay (sec / veh): 4.8
Level Of Service: A
Volume to Capacity (v/c): 0.018

Intersection Setup

Name	Cottonwood Street			Arlington Port Road			Beech Street			I-84 Ramps		
Approach	Northbound			Southbound			Eastbound			Westbound		
Lane Configuration	+			+			+			+		
Turning Movement	Left	Thru	Right	Left	Thru	Right	Left	Thru	Right	Left	Thru	Right
Lane Width	12.00	12.00	12.00	12.00	12.00	12.00	12.00	12.00	12.00	12.00	12.00	12.00
No. of Lanes in Pocket	0	0	0	0	0	0	0	0	0	0	0	0
Pocket Length	100.00/1	100.00/1	100.00/1	100.00/1	100.00/1	100.00/1	100.00/1	100.00/1	100.00/1	100.00/1	100.00/1	100.00/1
Speed	25.00			25.00			25.00			45.00		
Grade	0.00			0.00			0.00			0.00		
Crosswalk	no			no			no			no		

Volumes

Name	Cottonwood Street			Arlington Port Road			Beech Street			I-84 Ramps		
Base Volume Input [veh/h]	9	2	15	1	9	11	7	23	17	9	11	3
Base Volume Adjustment Factor	1.0000/1	1.0000/1	1.0000/1	1.0000/1	1.0000/1	1.0000/1	1.0000/1	1.0000/1	1.0000/1	1.0000/1	1.0000/1	1.0000/1
Heavy Vehicles Percentage [%]	22			18			11			16		
Growth Rate	1.00	1.00	1.00	1.00	1.00	1.00	1.00	1.00	1.00	1.00	1.00	1.00
In-Process Volume [veh/h]	0	0	0	0	0	0	0	0	0	0	0	0
Site-Generated Trips [veh/h]	0	0	0	0	0	0	0	0	0	0	0	0
Diverted Trips [veh/h]	0	0	0	0	0	0	0	0	0	0	0	0
Pass-by Trips [veh/h]	0	0	0	0	0	0	0	0	0	0	0	0
Existing Site Adjustment Volume [veh/h]	0	0	0	0	0	0	0	0	0	0	0	0
Other Volume [veh/h]	0	0	0	0	0	0	0	0	0	0	0	0
Right-Turn on Red Volume [veh/h]	0	0	0	0	0	0	0	0	0	0	0	0
Total Hourly Volume [veh/h]	9	2	15	1	9	11	7	23	17	9	11	3
Peak Hour Factor	0.6900/0	0.6900/0	0.6900/0	0.6900/0	0.6900/0	0.6900/0	0.6900/0	0.6900/0	0.6900/0	0.6900/0	0.6900/0	0.6900/0
Other Adjustment Factor	1.0000/1	1.0000/1	1.0000/1	1.0000/1	1.0000/1	1.0000/1	1.0000/1	1.0000/1	1.0000/1	1.0000/1	1.0000/1	1.0000/1
Total 15-Minute Volume [vehicles]	3	1	5	0	3	4	3	8	6	3	4	1
Total Analysis Volume [veh/h]	13	3	22	1	13	16	10	33	25	13	16	4
Pedestrian Volume [ped/h]	0			0			0			0		
Bicycle Volume [bicycles/h]	0			0			0			0		

Intersection Settings

Priority Scheme	Stop	Stop	Free	Free
-----------------	------	------	------	------

Movement, Approach, & Intersection Results

V/C, Movement V/C Ratio	0.02	0.00	0.02	0.00	0.02	0.02	0.01	0.00	0.00	0.01	0.00	0.00
d_M, Delay for Movement [s / veh]	9.32	9.32	9.32	9.34	9.34	9.34	7.35	0.00	0.00	7.49	0.00	0.00
Movement LOS	A	A	A	A	A	A	A	A	A	A	A	A
d_A, Approach Delay [s / veh]	9.32			9.34			1.08			2.95		
Approach LOS	A			A			A			A		
d_I, Intersection Delay [s / veh]	4.76											
Intersection LOS	A											

Intersection Level Of Service Report
#4: I-84 Ramps / Beech Street

Control Type: Two-way stop
Analysis Method: HCM2010
Analysis Period: 15 minutes

Delay (sec / veh): 3.0
Level Of Service: A
Volume to Capacity (v/c): 0.001

Intersection Setup

Name	Locust Street			I-84 Ramps			Access			Beech Street		
Approach	Northbound			Southbound			Eastbound			Westbound		
Lane Configuration	+			+			+			+		
Turning Movement	Left	Thru	Right	Left	Thru	Right	Left	Thru	Right	Left	Thru	Right
Lane Width	12.00	12.00	12.00	12.00	12.00	12.00	12.00	12.00	12.00	12.00	12.00	12.00
No. of Lanes in Pocket	0	0	0	0	0	0	0	0	0	0	0	0
Pocket Length	100.00/1	100.00/1	100.00/1	100.00/1	100.00/1	100.00/1	100.00/1	100.00/1	100.00/1	100.00/1	100.00/1	100.00/1
Speed	25.00			45.00			20.00			25.00		
Grade	0.00			0.00			0.00			0.00		
Crosswalk	no			no			no			no		

Volumes

Name	Locust Street			I-84 Ramps			Access			Beech Street		
Base Volume Input [veh/h]	1	41	11	9	30	1	1	1	1	14	1	14
Base Volume Adjustment Factor	1.0000/1	1.0000/1	1.0000/1	1.0000/1	1.0000/1	1.0000/1	1.0000/1	1.0000/1	1.0000/1	1.0000/1	1.0000/1	1.0000/1
Heavy Vehicles Percentage [%]	27			26			6			13		
Growth Rate	1.00	1.00	1.00	1.00	1.00	1.00	1.00	1.00	1.00	1.00	1.00	1.00
In-Process Volume [veh/h]	0	0	0	0	0	0	0	0	0	0	0	0
Site-Generated Trips [veh/h]	0	0	0	0	0	0	0	0	0	0	0	0
Diverted Trips [veh/h]	0	0	0	0	0	0	0	0	0	0	0	0
Pass-by Trips [veh/h]	0	0	0	0	0	0	0	0	0	0	0	0
Existing Site Adjustment Volume [veh/h]	0	0	0	0	0	0	0	0	0	0	0	0
Other Volume [veh/h]	0	0	0	0	0	0	0	0	0	0	0	0
Right-Turn on Red Volume [veh/h]	0	0	0	0	0	0	0	0	0	0	0	0
Total Hourly Volume [veh/h]	1	41	11	9	30	1	1	1	1	14	1	14
Peak Hour Factor	0.8000/0	0.8000/0	0.8000/0	0.8000/0	0.8000/0	0.8000/0	0.8000/0	0.8000/0	0.8000/0	0.8000/0	0.8000/0	0.8000/0
Other Adjustment Factor	1.0000/1	1.0000/1	1.0000/1	1.0000/1	1.0000/1	1.0000/1	1.0000/1	1.0000/1	1.0000/1	1.0000/1	1.0000/1	1.0000/1
Total 15-Minute Volume [vehicles]	0	13	3	3	9	0	0	0	0	4	0	4
Total Analysis Volume [veh/h]	1	51	14	11	38	1	1	1	1	18	1	18
Pedestrian Volume [ped/h]	0			0			0			0		
Bicycle Volume [bicycles/h]	0			0			0			0		

Intersection Settings

Priority Scheme	Free	Free	Stop	Stop
-----------------	------	------	------	------

Movement, Approach, & Intersection Results

V/C, Movement V/C Ratio	0.00	0.00	0.00	0.01	0.00	0.00	0.00	0.00	0.00	0.02	0.00	0.02
d_M, Delay for Movement [s / veh]	7.53	0.00	0.00	7.60	0.00	0.00	9.27	9.27	9.27	9.23	9.23	9.23
Movement LOS	A	A	A	A	A	A	A	A	A	A	A	A
d_A, Approach Delay [s / veh]	0.11			1.67			9.27			9.23		
Approach LOS	A			A			A			A		
d_I, Intersection Delay [s / veh]	2.95											
Intersection LOS	A											

**Intersection Level Of Service Report
#5: OR 74 / I-84 Eastbound Ramps**

Control Type: Two-way stop
Analysis Method: HCM2010
Analysis Period: 15 minutes

Delay (sec / veh): 2.1
Level Of Service: A
Volume to Capacity (v/c): 0.000

Intersection Setup

Name	OR 74			OR 74			I-84 Exit Ramp			I-84 Entrance Ramp		
Approach	Northbound			Southbound			Eastbound			Westbound		
Lane Configuration												
Turning Movement	Left	Thru	Right	Left	Thru	Right	Left	Thru	Right	Left	Thru	Right
Lane Width	12.00	12.00	12.00	12.00	12.00	12.00	12.00	12.00	12.00	12.00	12.00	12.00
No. of Lanes in Pocket	0	0	0	0	0	0	0	0	0	0	0	0
Pocket Length	100.00/1	100.00/1	100.00/1	100.00/1	100.00/1	100.00/1	100.00/1	100.00/1	100.00/1	100.00/1	100.00/1	100.00/1
Speed	55.00			55.00			45.00			45.00		
Grade	0.00			0.00			0.00			0.00		
Crosswalk	no			no			no			no		

Volumes

Name	OR 74			OR 74			I-84 Exit Ramp			I-84 Entrance Ramp		
Base Volume Input [veh/h]	0	5	9	1	6	0	1	1	4	0	0	0
Base Volume Adjustment Factor	1.0000/1	1.0000/1	1.0000/1	1.0000/1	1.0000/1	1.0000/1	1.0000/1	1.0000/1	1.0000/1	1.0000/1	1.0000/1	1.0000/1
Heavy Vehicles Percentage [%]	6			2			22			2		
Growth Rate	1.00	1.00	1.00	1.00	1.00	1.00	1.00	1.00	1.00	1.00	1.00	1.00
In-Process Volume [veh/h]	0	0	0	0	0	0	0	0	0	0	0	0
Site-Generated Trips [veh/h]	0	0	0	0	0	0	0	0	0	0	0	0
Diverted Trips [veh/h]	0	0	0	0	0	0	0	0	0	0	0	0
Pass-by Trips [veh/h]	0	0	0	0	0	0	0	0	0	0	0	0
Existing Site Adjustment Volume [veh/h]	0	0	0	0	0	0	0	0	0	0	0	0
Other Volume [veh/h]	0	0	0	0	0	0	0	0	0	0	0	0
Right-Turn on Red Volume [veh/h]	0	0	0	0	0	0	0	0	0	0	0	0
Total Hourly Volume [veh/h]	0	5	9	1	6	0	1	1	4	0	0	0
Peak Hour Factor	1.0000/1	0.7900/0	0.7900/0	0.7900/0	0.7900/0	1.0000/1	0.7900/0	0.7900/0	0.7900/0	0.7900/0	0.7900/0	0.7900/0
Other Adjustment Factor	1.0000/1	1.0000/1	1.0000/1	1.0000/1	1.0000/1	1.0000/1	1.0000/1	1.0000/1	1.0000/1	1.0000/1	1.0000/1	1.0000/1
Total 15-Minute Volume [vehicles]	0	2	3	0	2	0	0	0	1	0	0	0
Total Analysis Volume [veh/h]	0	6	11	1	8	0	1	1	5	0	0	0
Pedestrian Volume [ped/h]	0			0			0			0		
Bicycle Volume [bicycles/h]	0			0			0			0		

Intersection Settings

Priority Scheme	Free	Free	Stop	Stop
-----------------	------	------	------	------

Movement, Approach, & Intersection Results

V/C, Movement V/C Ratio	0.00	0.00	0.00	0.00	0.00	0.00	0.00	0.00	0.00	0.00	0.00	0.00
d_M, Delay for Movement [s / veh]	0.00	0.00	0.00	7.25	0.00	0.00	8.72	8.72	8.72	8.72	8.72	8.72
Movement LOS		A	A	A	A		A	A	A	A	A	A
d_A, Approach Delay [s / veh]	0.00			0.81			8.72			8.72		
Approach LOS	A			A			A			A		
d_I, Intersection Delay [s / veh]	2.07											
Intersection LOS	A											

Intersection Level Of Service Report
#6: OR 19 / Cedar Springs Lane

Control Type: Two-way stop
 Analysis Method: HCM2010
 Analysis Period: 15 minutes

Delay (sec / veh): 5.9
 Level Of Service: A
 Volume to Capacity (v/c): 0.058

Intersection Setup

Name	OR 19		OR 19		Cedar Springs Lane	
Approach	Northbound		Southbound		Eastbound	
Lane Configuration	←		↑		→	
Turning Movement	Left	Thru	Thru	Right	Left	Right
Lane Width	12.00	12.00	12.00	12.00	12.00	12.00
No. of Lanes in Pocket	0	0	0	1	0	0
Pocket Length	100.00	100.00	100.00	175.00	100.00	100.00
Speed	55.00		55.00		45.00	
Grade	0.00		0.00		0.00	
Crosswalk	no		no		no	

Volumes

Name	OR 19		OR 19		Cedar Springs Lane	
Base Volume Input [veh/h]	1	8	15	8	47	6
Base Volume Adjustment Factor	1.0000	1.0000	1.0000	1.0000	1.0000	1.0000
Heavy Vehicles Percentage [%]	10		17		40	
Growth Rate	1.00	1.00	1.00	1.00	1.00	1.00
In-Process Volume [veh/h]	0	0	0	0	0	0
Site-Generated Trips [veh/h]	0	0	0	0	0	0
Diverted Trips [veh/h]	0	0	0	0	0	0
Pass-by Trips [veh/h]	0	0	0	0	0	0
Existing Site Adjustment Volume [veh/h]	0	0	0	0	0	0
Other Volume [veh/h]	0	0	0	0	0	0
Right-Turn on Red Volume [veh/h]	0	0	0	0	0	0
Total Hourly Volume [veh/h]	1	8	15	8	47	6
Peak Hour Factor	0.9100	0.9100	0.9100	0.9100	0.9100	0.9100
Other Adjustment Factor	1.0000	1.0000	1.0000	1.0000	1.0000	1.0000
Total 15-Minute Volume [vehicles]	0	2	4	2	13	2
Total Analysis Volume [veh/h]	1	9	16	9	52	7
Pedestrian Volume [ped/h]	0		0		0	
Bicycle Volume [bicycles/h]	0		0		0	

Intersection Settings

Priority Scheme	Free	Free	Free	Stop
-----------------	------	------	------	------

Movement, Approach, & Intersection Results

V/C, Movement V/C Ratio	0.00	0.00	0.00	0.00	0.06	0.01
d_M, Delay for Movement [s / veh]	7.34	0.00	0.00	0.00	9.25	9.25
Movement LOS	A	A	A	A	A	A
d_A, Approach Delay [s / veh]	0.73		0.00		9.25	
Approach LOS	A		A		A	
d_I, Intersection Delay [s / veh]	5.88					
Intersection LOS	A					

Gilliam County TSP

Vistro File: H:\...\existing conditions.vistro

Scenario: Base Scenario

Report File: H:\...\existingconditions_report.pdf

11/25/2014

Turning Movement Volume: Summary

ID	Intersection Name	Northbound			Southbound			Eastbound			Westbound			Total Volume
		Left	Thru	Right	Left	Thru	Right	Left	Thru	Right	Left	Thru	Right	
2	Main Street/E Bayard Street	2	26	5	23	26	11	16	1	3	1	1	19	134

ID	Intersection Name	Northbound			Southbound			Eastbound			Westbound			Total Volume
		Left	Thru	Right	Left	Thru	Right	Left	Thru	Right	Left	Thru	Right	
3	Cottonwood Street / Beech Street	9	2	15	1	9	11	7	23	17	9	11	3	117

ID	Intersection Name	Northbound			Southbound			Eastbound			Westbound			Total Volume
		Left	Thru	Right	Left	Thru	Right	Left	Thru	Right	Left	Thru	Right	
4	I-84 Ramps / Beech Street	1	41	11	9	30	1	1	1	1	14	1	14	125

ID	Intersection Name	Northbound		Southbound		Eastbound			Westbound			Total Volume
		Thru	Right	Left	Thru	Left	Thru	Right	Left	Thru	Right	
5	OR 74 / I-84 Eastbound Ramps	5	9	1	6	1	1	4	0	0	0	27

ID	Intersection Name	Northbound		Southbound		Eastbound		Total Volume
		Left	Thru	Thru	Right	Left	Right	
6	OR 19 / Cedar Springs Lane	1	8	15	8	47	6	85

Lane Configuration and Traffic Control

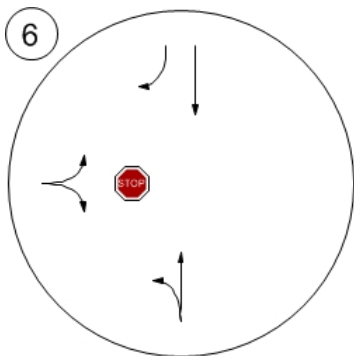
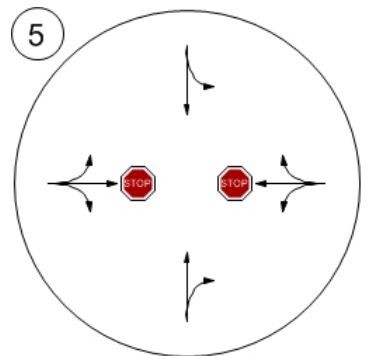
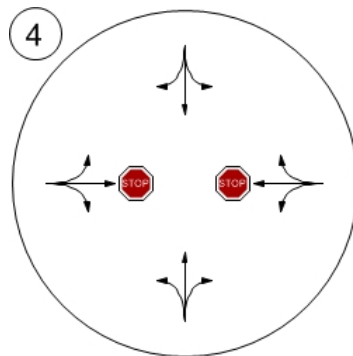
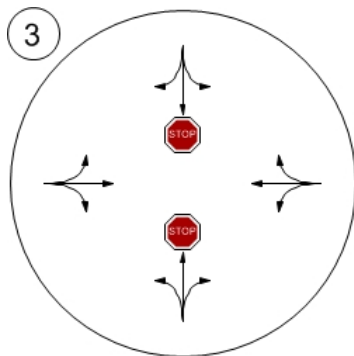
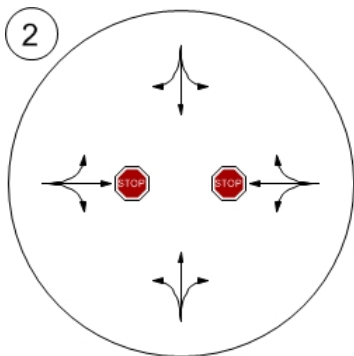
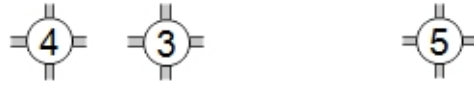

Traffic Volume - Base Volume

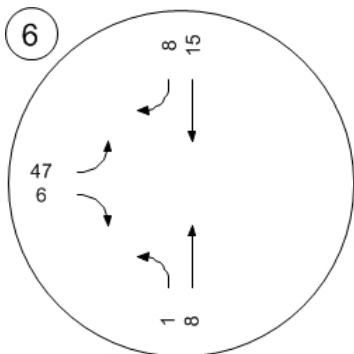
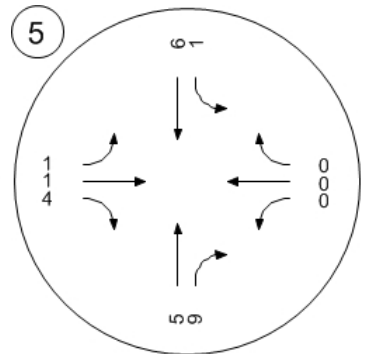
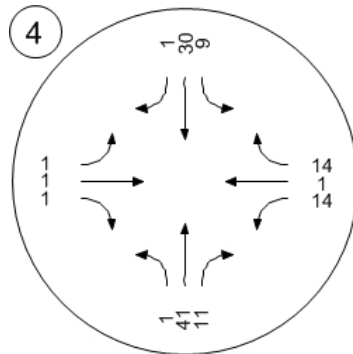
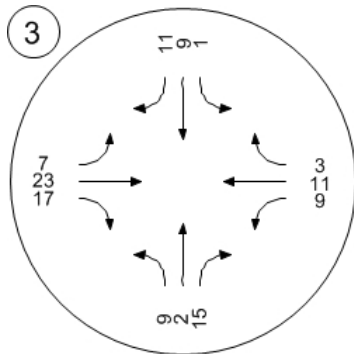
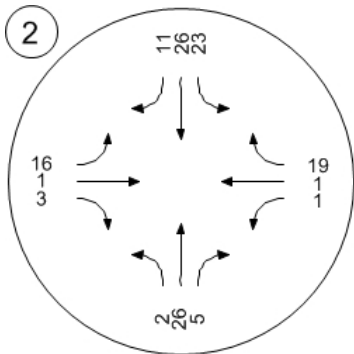
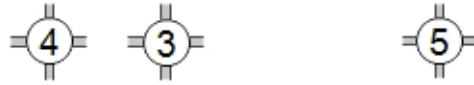

Traffic Conditions

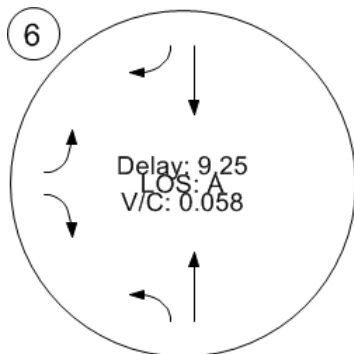
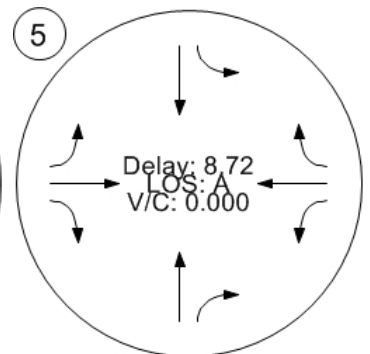
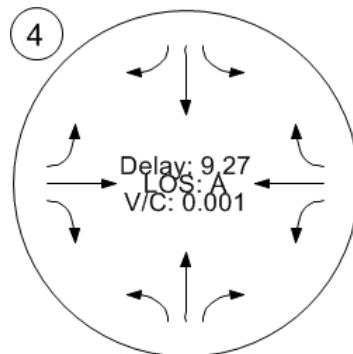
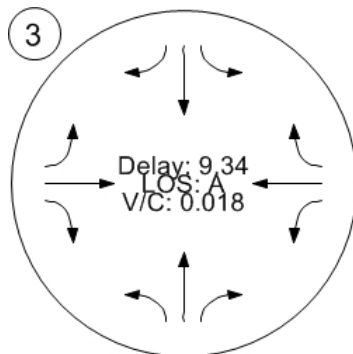
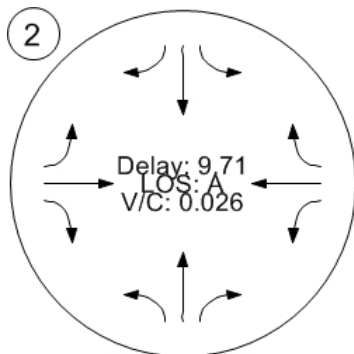
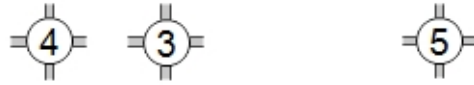

DRAFT

Appendix 6 ODOT Crash Data

1432033	September	8	2011	Thursday	7:00 AM	Gilliam	Rural Minor Arterial	Wasco-Heppner	33.7	55	roadway and considered "located"	Fixed object	Fixed-Object or Other-Object	Non-fatal injury crash	Clear	Dry	Daylight	No control (as stated on Police Report)	Cut slope or ditch embankment	Cut slope or ditch embankment	Speed too fast for conditions (not exceeding limit)	No	No	No	Yes	
1432034	August	17	2011	Wednesday	2:00 PM	Gilliam	Rural Minor Arterial	Heppner	2	55	Grade (vertical curve)	Fixed object	Fixed-Object or Other-Object	Non-fatal injury crash	Clear	Dry	Daylight	Unknown or not defined	Guard rail (not metal median barrier)	Fence or building, etc.	Driving in excess of posted speed	No	No	No	Yes	
1432038	October	25	2011	Tuesday	1:00 PM	Gilliam	Rural Local Street or Road	Heppner	4.4	55	roadway and considered "located"	Fixed object	Fixed-Object or Other-Object	Property damage only crash (PDO)	Clear	Unknown	Daylight	Unknown or not defined	Cut slope or ditch embankment	Slides, rocks off or on road, falling rocks	Speed too fast for conditions (not exceeding limit)	No	No	No	Yes	
1432043	December	22	2011	Thursday	3:00 PM	Gilliam	Rural Local Street or Road	Heppner	8.55	55	roadway and considered "located"	From opposite direction - both going straight	Sideways-meeting	Property damage only crash (PDO)	Clear	Dry	Daylight	Unknown or not defined	Cut slope or ditch embankment	Sliding or swerving due to wet, icy, slippery or loose surface	Speed too fast for conditions (not exceeding limit)	No	No	No	Yes	
1432050	December	8	2011	Thursday	5:00 PM	Gilliam	Rural Local Street or Road	Heppner	5.75	55	roadway and considered "located"	Animal	Miscellaneous	Property damage only crash (PDO)	Clear	Dry	Dusk (Twilight)	Unknown or not defined	Deer or elk, wapiti	Other (not improper driving)	Speed too fast for conditions (not exceeding limit)	No	No	No	No	
1432055	September	27	2011	Tuesday	1:00 PM	Gilliam	Rural Major Collector	Heppner	7.31	55	roadway and considered "located"	Paralel motor vehicle	Non-collision	Non-fatal injury crash	Clear	Dry	Daylight	Unknown or not defined	Vehicle lost load or load shifted	Other (not improper driving)	Speed too fast for conditions (not exceeding limit)	No	No	No	Yes	
1432058	September	25	2011	Sunday	1:00 AM	Gilliam	Rural Major Collector	Heppner	9.24	55	roadway and considered "located"	&	Non-collision	Non-fatal injury crash	Clear	Dry	Darkness - no street lights	Unknown or not defined	Other (not improper driving)	Speed too fast for conditions (not exceeding limit)	No	No	No	No		
1433099	December	13	2011	Tuesday	6:00 AM	Gilliam	Rural Principal Arterial - Interstate	Columbia River	125.09	55	Straight roadway	From same direction - one stopped	Rear-End	Non-fatal injury crash	Fog	Dry	Darkness - no street lights	Median barrier	Guard rail (not metal median barrier)	Driver drowsy / fatigued / sleepy	Speed too fast for conditions (not exceeding limit)	No	Yes	No	Yes	
143984	September	13	2011	Thursday	9:00 AM	Gilliam	Rural Principal Arterial - Interstate	Columbia River	147.9	65	Grade (vertical curve)	Fixed object	Fixed-Object or Other-Object	Non-fatal injury crash	Clear	Dry	Daylight	One way street	Median barrier (raised or metal)	Overturned after first harmful event	Speed too fast for conditions (not exceeding limit)	No	No	No	Yes	
1451003	February	6	2012	Monday	6:00 AM	Gilliam	Rural Major Collector	Columbia River	6.09	55	roadway and considered "located"	Fixed object	Fixed-Object or Other-Object	Property damage only crash (PDO)	Fog	Ice	Dawn (Twilight)	No control (as stated on Police Report)	Cut slope or ditch embankment	Overturned after first harmful event	Speed too fast for conditions (not exceeding limit)	No	No	No	Yes	
1451005	January	18	2012	Wednesday	6:00 PM	Gilliam	Rural Principal Arterial - Interstate	Columbia River	126.09	65	Straight roadway	Fixed object	Fixed-Object or Other-Object	Property damage only crash (PDO)	Cloudy	Ice	Darkness - no street lights	Median barrier	Guard rail (not metal median barrier)	Median barrier (raised or metal)	Speed too fast for conditions (not exceeding limit)	No	No	No	Yes	
1451007	January	19	2012	Thursday	4:00 AM	Gilliam	Rural Principal Arterial - Interstate	Columbia River	116	55	Straight roadway	From same direction - both going straight	Sideways-overtaking	Property damage only crash (PDO)	Cloudy	Ice	Darkness - no street lights	Median barrier	Sliding or swerving due to wet, icy, slippery or loose surface	Crash related to another separate crash	Speed too fast for conditions (not exceeding limit)	No	No	No	Yes	
1451008	January	19	2012	Thursday	4:00 AM	Gilliam	Rural Principal Arterial - Interstate	Columbia River	116	55	Straight roadway	From same direction - both going straight	Sideways-overtaking	Property damage only crash (PDO)	Cloudy	Ice	Darkness - no street lights	Median barrier	Vehicle forced by impact into another vehicle, cyclist or pedestrian	Crash related to another separate crash	Speed too fast for conditions (not exceeding limit)	No	No	No	Yes	
1451009	January	18	2012	Wednesday	7:00 AM	Gilliam	Rural Principal Arterial - Interstate	Columbia River	122.41	55	Straight roadway	Fixed object	Fixed-Object or Other-Object	Non-fatal injury crash	Snow	Ice	Daylight	Median barrier	Guard rail (not metal median barrier)	Careless Driving	Speed too fast for conditions (not exceeding limit)	No	No	No	Yes	
1451010	January	21	2012	Saturday	10:00 AM	Gilliam	Rural Principal Arterial - Interstate	Columbia River	149.35	65	Grade (vertical curve)	Overturned	Non-collision	Property damage only crash (PDO)	Clear	Ice	Daylight	One way street	Sliding or swerving due to wet, icy, slippery or loose surface	Speed too fast for conditions (not exceeding limit)	No	No	No	Yes		
1451011	January	23	2012	Monday	4:00 AM	Gilliam	Rural Principal Arterial - Interstate	Columbia River	133.56	65	Straight roadway	Overturned	Non-collision	Property damage only crash (PDO)	Rain	Ice	Daylight	Darkness - no street lights	Cut slope or ditch embankment	Sliding or swerving due to wet, icy, slippery or loose surface	Speed too fast for conditions (not exceeding limit)	No	No	No	Yes	
1451014	January	29	2012	Sunday	6:00 AM	Gilliam	Rural Principal Arterial - Interstate	Columbia River	146.79	65	Straight roadway	Fixed object	Fixed-Object or Other-Object	Property damage only crash (PDO)	Clear	Dry	Darkness - no street lights	One way street	Guard rail (not metal median barrier)	Careless Driving	Speed too fast for conditions (not exceeding limit)	No	No	No	Yes	
1451016	March	29	2012	Thursday	7:00 AM	Gilliam	Rural Principal Arterial - Interstate	Columbia River	122.2	65	Straight roadway	Fixed object	Fixed-Object or Other-Object	Property damage only crash (PDO)	Cloudy	Dry	Daylight	Median barrier	Median barrier (raised or metal)	Driving in excess of posted speed	Speed too fast for conditions (not exceeding limit)	No	No	No	Yes	
1451018	April	15	2012	Sunday	9:00 PM	Gilliam	Rural Principal Arterial - Interstate	Columbia River	130.43	65	Grade (vertical curve)	Overturned	Non-collision	Property damage only crash (PDO)	Clear	Dry	Darkness - no street lights	Median barrier	Trailer or towed vehicle overturned	Other (not improper driving)	Speed too fast for conditions (not exceeding limit)	No	Yes	No	Yes	
1451021	April	18	2012	Wednesday	7:00 AM	Gilliam	Rural Principal Arterial - Interstate	Columbia River	133.87	65	Straight roadway	Overturned	Non-collision	Non-fatal injury crash	Clear	Dry	Daylight	One way street	Careless Driving	Speed too fast for conditions (not exceeding limit)	No	Yes	No	Yes		
1451022	February	10	2012	Friday	1:00 PM	Gilliam	Rural Minor Arterial	John Day	6.07	55	Straight roadway	Overturned	Non-collision	Non-fatal injury crash	Clear	Dry	Daylight	Unknown or not defined	Careless Driving	Speed too fast for conditions (not exceeding limit)	No	No	No	No		
1451023	February	14	2012	Tuesday	7:00 AM	Gilliam	Rural Minor Arterial	John Day	26.43	55	roadway and considered "located"	Fixed object	Fixed-Object or Other-Object	Non-fatal injury crash	Clear	Ice	Daylight	Unknown or not defined	Cut slope or ditch embankment	Overturned after first harmful event	Speed too fast for conditions (not exceeding limit)	No	No	No	Yes	
1451024	March	22	2012	Thursday	6:00 AM	Gilliam	Rural Minor Arterial	John Day	13.38	55	Straight roadway	Fixed object	Fixed-Object or Other-Object	Non-fatal injury crash	Cloudy	Snow	Darkness - no street lights	Unknown or not defined	Cut slope or ditch embankment	Overturned after first harmful event	Driving in excess of posted speed	No	No	No	Yes	
1451029	March	31	2012	Saturday	7:00 PM	Gilliam	Rural Minor Arterial	Wasco-Heppner	25.18	55	Straight roadway	Overturned	Non-collision	Non-fatal injury crash	Rain	Wet	Dusk (Twilight)	No control (as stated on Police Report)	Driving in excess of posted speed	Driving in excess of posted speed	Speed too fast for conditions (not exceeding limit)	No	No	No	Yes	
1452231	April	7	2012	Thursday	12:00 PM	Gilliam	Rural Minor Arterial	John Day	23.21	45	roadway and considered "located"	Fixed object	Fixed-Object or Other-Object	Non-fatal injury crash	Clear	Dry	Daylight	Unknown or not defined	Delineator or marker (reflector posts)	Guard rail (not metal median barrier)	Speed too fast for conditions (not exceeding limit)	No	Yes	No	Yes	
1461610	May	28	2012	Monday	11:00 AM	Gilliam	Rural Minor Arterial	John Day	37.5	55	Streetroad or highway intersection	Entering at angle - all others	Angle	Property damage only crash (PDO)	Clear	Dry	Daylight	Stop sign	Vegetation obscured view	Did not yield right-of-way	Speed too fast for conditions (not exceeding limit)	No	No	No	No	
1461611	July	3	2012	Tuesday	9:00 AM	Gilliam	Rural Principal Arterial - Interstate	Columbia River	124.43	65	Straight roadway	From same direction - both going straight	Rear-End	Property damage only crash (PDO)	Clear	Dry	Daylight	Median barrier	Inattention	Other (not improper driving)	Speed too fast for conditions (not exceeding limit)	No	No	No	No	
1461613	June	15	2012	Friday	8:00 PM	Gilliam	Rural Principal Arterial - Interstate	Columbia River	125.48	65	Straight roadway	Fixed object	Fixed-Object or Other-Object	Non-fatal injury crash	Clear	Wet	Daylight	Median barrier	Median barrier (raised or metal)	Other (not improper driving)	Driving in excess of posted speed	No	No	No	No	
1461615	June	21	2012	Thursday	11:00 PM	Gilliam	Rural Principal Arterial - Interstate	Columbia River	127.56	65	Straight roadway	Fixed object	Fixed-Object or Other-Object	Non-fatal injury crash	Clear	Dry	Darkness - with street lights	Median barrier	Median barrier (raised or metal)	Guard rail (not metal median barrier)	Driving in excess of posted speed	No	No	No	Yes	
1461616	May	3	2012	Saturday	7:00 AM	Gilliam	Rural Major Collector	Heppner	1.1	55	Grade (vertical curve)	Overturned	Non-collision	Non-fatal injury crash	Clear	Dry	Daylight	No control (as stated on Police Report)	Deer or elk, wapiti	Speed too fast for conditions (not exceeding limit)	No	No	No	Yes		
1464025	July	13	2012	Friday	7:00 PM	Gilliam	Rural Local Street or Road	Heppner	0.93	55	roadway and considered "located"	Fixed object	Fixed-Object or Other-Object	Non-fatal injury crash	Clear	Dry	Daylight	No control (as stated on Police Report)	Cut slope or ditch embankment	Overturned after first harmful event	Speed too fast for conditions (not exceeding limit)	No	No	No	Yes	
1482006	August	16	2012	Thursday	1:00 PM	Gilliam	Rural Principal Arterial - Interstate	Columbia River	115.26	65	roadway and considered "located"	From same direction - both going straight	Rear-End	Non-fatal injury crash	Clear	Dry	Daylight	Median barrier	Followed too closely	Yes	No	No	No	No		
1482009	July	19	2012	Thursday	9:00 AM	Gilliam	Rural Principal Arterial - Interstate	Columbia River	124.93	55	Straight roadway	From same direction - both going straight	Sideways-overtaking	Property damage only crash (PDO)	Clear	Dry	Daylight	Median barrier	Improper overtaking	Speed too fast for conditions (not exceeding limit)	No	No	No	No		
1482011	December	16	2012	Sunday	12:00 AM	Gilliam	Rural Principal Arterial - Interstate	Columbia River	123.56	55	roadway and considered "located"	Fixed object	Fixed-Object or Other-Object	Property damage only crash (PDO)	Clear	Ice	Darkness - no street lights	Median barrier	Parked improperly parked	Speed too fast for conditions (not exceeding limit)	No	No	No	No		
1482012	December	30	2012	Sunday	6:00 AM	Gilliam	Rural Principal Arterial - Interstate	Columbia River	124.45	65	Straight roadway	Fixed object	Fixed-Object or Other-Object	Property damage only crash (PDO)	Cloudy	Ice	Dawn (Twilight)	Median barrier	Cut slope or ditch embankment	Overturned after first harmful event	Speed too fast for conditions (not exceeding limit)	No	No	No	Yes	
1482013	September	21	2012	Friday	5:00 PM	Gilliam	Rural Principal Arterial - Interstate	Columbia River	126.93	65	Straight roadway	Fixed object	Fixed-Object or Other-Object	Property damage only crash (PDO)	Cloudy	Dry	Daylight	Median barrier	Median barrier (raised or metal)	Guard rail (not metal median barrier)	Speed too fast for conditions (not exceeding limit)	No	No	No	Yes	
1482015	October	26	2012	Friday	7:00 PM	Gilliam	Rural Principal Arterial - Interstate	Columbia River	132	65	Straight roadway	Animal	Miscellaneous	Property damage only crash (PDO)	Clear	Dry	Darkness - no street lights	One way street	Deer or elk, wapiti	Driving in excess of posted speed	Speed too fast for conditions (not exceeding limit)	No	No	No	Yes	
1482017	November	9	2012	Friday	7:00 PM	Gilliam	Rural Principal Arterial - Interstate	Columbia River	133.56	65	Straight roadway	From same direction - both going straight	Rear-End	Non-fatal injury crash	Cloudy	Dry	Darkness - no street lights	One way street	Driving in excess of posted speed	Speed too fast for conditions (not exceeding limit)	No	No	No	Yes		
1482019	November	5	2012	Monday	7:00 AM	Gilliam	Rural Principal Arterial - Interstate	Columbia River	138.82	65	Grade (vertical curve)	From same direction - both going straight	Rear-End	Property damage only crash (PDO)	Clear	Dry	Daylight	Median barrier	Careless Driving	Speed too fast for conditions (not exceeding limit)	No	No	No	Yes		
1482021	August	1	2012	Wednesday	6:00 PM	Gilliam	Rural Principal Arterial - Interstate	Columbia River	141.59	65	roadway and considered "located"	Fixed object	Fixed-Object or Other-Object	Property damage only crash (PDO)	Clear	Dry	Daylight	One way street	Delineator or marker (reflector posts)	Careless Driving	Speed too fast for conditions (not exceeding limit)	No	No	No	Yes	
1482022	December	26	2012	Wednesday	2:00 PM	Gilliam	Rural Principal Arterial - Interstate	Columbia River	142.82	65	Straight roadway	Overturned	Non-collision	Non-fatal injury crash	Clear	Wet	Daylight	One way street	Delineator or marker (reflector posts)	Reckless Driving	Speed too fast for conditions (not exceeding limit)	No	No	No	Yes	
1482023	November	24	2012	Saturday	10:00 PM	Gilliam	Rural Principal Arterial - Interstate	Columbia River	146.35	65	Straight roadway	Fixed object	Fixed-Object or Other-Object	Non-fatal injury crash	Cloudy	Dry	Darkness - no street lights	One way street	Guard rail (not metal median barrier)	Deer or elk, wapiti	Other (not improper driving)	Speed too fast for conditions (not exceeding limit)	No	No	No	No
1482026	November	29	2012	Thursday	7:00 PM	Gilliam	Rural Principal Arterial - Interstate	Columbia River	148.85	55	Straight roadway	Fixed object	Fixed-Object or Other-Object	Property damage only crash (PDO)	Rain	Wet	Darkness - no street lights	One way street	Call phone (on PAR or driver in use)	Inattention	Speed too fast for conditions (not exceeding limit)	No	No	No	No	
1482029	August	9	2012	Thursday	12:00 PM	Gilliam	Rural Minor Arterial	John Day	41.64	55	roadway and considered "located"	Other non-collision	Non-collision	Non-fatal injury crash	Clear	Dry	Daylight	Unknown or not defined	Tire failure	Occupant fell jumped, was ejected from moving vehicle	Tire failure	Speed too fast for conditions (not exceeding limit)	No	No	No	No
1482030	August	24	2012	Friday	4:00 PM	Gilliam	Rural Minor Arterial	John Day	45.29	55	Streetroad or highway intersection	Fixed object	Fixed-Object or Other-Object	Property damage only crash (PDO)	Clear	Dry	Daylight	Stop sign	Cut slope or ditch embankment	Berm (earth or gravel mound)	Speed too fast for conditions (not exceeding limit)	No	No	No	Yes	
1482031	August	10	2012	Friday	2:00 PM	Gilliam	Rural Minor Arterial	Wasco-Heppner	23.12	55	roadway and considered "located"	Fixed object	Fixed-Object or Other-Object	Non-fatal injury crash	Clear	Dry	Daylight	No control (as stated on Police Report)	Cut slope or ditch embankment	Inattention	Other sign, including street signs	Speed too fast for conditions (not exceeding limit)	No	No	No	Yes
1482033	December	15	2012	Saturday	8:00 AM	Gilliam	Rural Minor Arterial	Wasco-Heppner	18.9	55	roadway and considered "located"	Fixed object	Fixed-Object or Other-Object	Non-fatal injury crash	Cloudy	Ice	Daylight	No control (as stated on Police Report)	Cut slope or ditch embankment	Sliding or swerving due to wet, icy, slippery or loose surface	Speed too fast for conditions (not exceeding limit)	No	No	No	Yes	
1482035	September	1	2012	Saturday	1:00 PM	Gilliam	Rural Local Street or Road	Heppner	0.09	55	roadway and considered "located"	Fixed object	Fixed-Object or Other-Object	Non-fatal injury crash	Clear	Dry	Daylight	No control (as stated on Police Report)	Cut slope or ditch embankment	Speed too fast for conditions (not exceeding limit)	No	No	No	Yes		
1482038	November	5	2012	Monday	12:00 PM	Gilliam	Rural Major Collector	Heppner	7.6	55	roadway and considered "located"	&	Non-collision	Property damage only crash (PDO)	Clear	Dry	Daylight	No control (as stated on Police Report)	Cut slope or ditch embankment	Speed too fast for conditions (not exceeding limit)	No	No	No	Yes		
1482041	July	13	2012	Friday	5:00 PM	Gilliam	Rural Local Street or Road	Heppner	10	55	roadway and considered "located"	&	Non-collision	Non-fatal injury crash	Clear	Dry	Daylight	No control (as stated on Police Report)	Deer or elk, wapiti	Phantom / non-contact vehicle	Speed too fast for conditions (not exceeding limit)	No	No	No	No	
1503685	March	17	2013	Friday	4:00 PM	Gilliam	Rural Principal Arterial - Interstate	Columbia River	122.93	65	Straight roadway	Other non-collision	Non-collision	Property damage only crash (PDO)	Clear	Dry	Daylight	Median barrier	Wheel came off	Fire or Explosion	Tire failure	Speed too fast for conditions (not exceeding limit)	No	No	No	No
1503688	January	5	2013	Saturday	7:00 PM	Gilliam	Rural Principal Arterial - Interstate	Columbia River	136	65	Grade (vertical curve)	Fixed object	Fixed-Object or Other-Object	Non-fatal injury crash	Snow	Ice	Darkness - no street lights	One way street	Guard rail (not metal median barrier)	Overturned after first harmful event	Speed too fast for conditions (not exceeding limit)	No	No	No	Yes	
1503689	March	29	2013	Friday	3:00 PM	Gilliam	Rural Principal Arterial - Interstate	Columbia River	136.3	65	Grade (vertical curve)	From same direction - both going straight	Sideways-overtaking	Property damage only crash (PDO)	Clear	Dry	Daylight	One way street	Driving in excess of posted speed	Driving in excess of posted speed	Speed too fast for conditions (not exceeding limit)	No	No	No	Yes	
1503690	February	25	2013	Monday	2:00 PM	Gilliam	Rural Principal Arterial - Interstate	Columbia River	146.35	65	Grade (vertical curve)	Fixed object	Fixed-Object or Other-Object	Non-fatal injury crash	Clear	Dry	Daylight	One way street	Cut slope or ditch embankment	Wind gust	Driving in excess of posted speed	No	No	No	Yes	
1503691	March	29	2013	Friday	7:00 AM	Gilliam	Rural Minor Arterial	Heppner	5.45	55	Grade (vertical curve)	Animal	Miscellaneous	Property damage only crash (PDO)	Cloudy	Dry	Daylight	Unknown or not defined	Deer or elk, wapiti	Other (not improper driving)	Speed too fast for conditions (not exceeding limit)	No	No	No	No	
1504085	January	19	2013	Saturday	7:00 PM	Gilliam	Rural Major Collector	Heppner	6.75	55	roadway and considered "located"	Overturned	Non-collision	Property damage only crash (PDO)	Clear	Dry	Darkness - no street lights	No control (as stated on Police Report)	Fence or building, etc.	Driving in excess of posted speed	Speed too fast for conditions (not exceeding limit)	No	No	No	Yes	
1508827	June	13	2013	Thursday	5:00 AM	Gilliam	Rural Minor Arterial	John Day	4.59	55	Straight roadway	From same direction - both going straight	Sid													